

WinEVM
Event Manager
For Windows

Programming Manual

WinEVM Version 3.0

DCN 141-00550-30

6/12/01

v3.07

Important Information

WinEVM "Event Manager" software supports a broad family of controller products from a simple X10 controller to a full featured Home Automation system that includes multiple serial ports, telephone access, voice response and on-board IO.

This manual describes all the features and commands supported by WinEVM software, however, your controller may not support all of these.

Check your Hardware Installation Manual for a list of the features and commands that your controller model supports.

If you have questions about your hardware or the *WinEVM* software supplied with your controller, contact the manufacture of the product for further information.

WinEVM 3.0!

This manual is for ***WinEVM Version 3.0*** and later releases.

This version is a major enhancement to previous versions of *WinEVM*. Most important is the addition of RS485 network devices. Also new is the support for RS232 subsystems. First in this release are Security subsystems (alarm panels with serial ports).

With the addition of RS485 Network Devices and RS232 Subsystems, *WinEVM* is poised to add many new supported devices. Look for an array of RS485 devices and additional Security Systems and Lighting Control Systems to be added soon.

Some of the new features of version 3.0 are:

- Support for RS485 network devices.
 - RCS Thermostats and Zone Controllers
 - 7 Button LED Keypad
 - 8 Button LCD Keypad
 - 8 Channel Relay Control Unit
- Support for RS232 Subsystems.
 - Security Systems
 - CADDX
- Increased Thermostat support for up to 32 zones on the RS485 Link.

Table of Contents

Chapter 1. Installing WinEVM..... 1

<i>Before you Start</i>	1
<i>Installing WinEVM:</i>	1
<i>Starting WinEVM:</i>	1

Chapter 2. What is Event Manager? 3

<i>How Event Manager Works</i>	3
--------------------------------------	---

Chapter 3. WinEVM Main Menu..... 6

<i>Main Menu</i>	6
------------------------	---

Chapter 4. FILE Menu..... 9

<i>File – New Schedule</i>	9
<i>File – Open Schedule</i>	9
<i>File – Save Schedule</i>	9
<i>File - Save Schedule As</i>	9
<i>File - Rules Check</i>	9
<i>File – DownLoad</i>	11
<i>File – Print</i>	11
<i>File – Print Schedule</i>	12
<i>File – Exit</i>	12

Chapter 5. EDIT Menu..... 14

<i>Selecting Items to Edit</i>	14
<i>Edit – Cut</i>	14
<i>Edit – Copy</i>	14
<i>Edit – Paste</i>	14
<i>Edit – Select All</i>	15
<i>Edit – Find</i>	15
<i>Edit – Next</i>	15
<i>Edit – Freeze</i>	15
<i>Edit – Thaw</i>	15

Chapter 6. DEFINE Menu 16

<i>Creating the Device Database</i>	16
<i>Define - X10 Device</i>	16
<i>Define - Timers</i>	17

<i>Define - Time Labels</i>	17
<i>Define - Flags</i>	19
<i>Define - Variables</i>	19
<i>Define - IF Macros</i>	20
<i>Define - THEN Macros</i>	22
<i>Define – IR and IO Devices</i>	23
<i>Define - 8CH Relay</i>	27
<i>Define - LCD Keypad</i>	28
<i>Define - LED Keypad</i>	29
<i>Define - HVAC</i>	30
<i>Define - Telephone</i>	30
<i>Define - VoiceMenu/VoiceMail</i>	33
<i>Define - VoiceMail-Remote Access</i>	39
<i>Define - User Voice Responses</i>	46
<i>Define - COM Ports</i>	48
<i>Define – Security</i>	48

Chapter 7. UTILITIES Menu 51

<i>Utilities - Mega Controller</i>	51
<i>Utilities - Start Schedule</i>	52
<i>Utilities - Halt Schedule</i>	52
<i>Utilities - Clear Schedule</i>	52
<i>Utilities - TimeDate Set</i>	52
<i>Utilities - X10 Signal Test</i>	53
<i>Utilities - System Info</i>	54
<i>Utilities - Message Log</i>	54
<i>Utilities – Telephone Log</i>	54
<i>Utilities – Voice Mail</i>	55
<i>Utilities - Network Info</i>	55
<i>Utilities - Self Test</i>	55
<i>Utilities - Modem</i>	55
<i>Utilities - Fonts</i>	58
<i>Utilities - Options</i>	59
<i>Other Main Menus</i>	59

Chapter 8. Event Programming 60

<i>Basic Event Structure</i>	60
<i>Multiple Condition Events</i>	61
<i>Multiple Action Events</i>	62
<i>Fast Events</i>	63
<i>Nesting</i>	63
<i>Summary of 'IF' conditions</i>	63

Summary of 'THEN' actions:.....	65	IF - Telephone	97
Chapter 9.		IF - VoiceMail	99
Event Processing.....	67	IF - LCD DigitPad	100
Standard Events.....	67	IF – Security.....	102
Fast Events	67	Chapter 13.	
IF/THEN/ELSE Events.....	67	THEN/ELSE Actions	105
Chapter 10.		Then/Else Action Menu	105
A Tour of Event Manager	70	Then - X10 Device.....	106
A Case Study: Otto Mashon uses X10 to control lights		Then - Timer/Delay.....	107
and radio.....	70	Then – Flag.....	108
Chapter 11.		Then - Variable.....	109
Event Editor.....	76	Then - Message Log.....	110
Using the Event Editor to Create an Event	76	Then - THEN Macro	111
New Event	76	Then - Comment.....	111
Adding If Conditions and Then Actions to Events.....	77	Then - IR.....	112
Edit Event.....	77	Then - ASCII Out	112
Delete Event.....	77	Then - Nested IF/THEN.....	114
Chapter 12.		Then - Relay Output	115
IF Conditions.....	78	Then – HVAC.....	115
IF Condition Menu	78	Then - Telephone	116
IF - X10 Device State.....	79	Then - Voice Functions	118
IF- X10 Sequence.....	82	Then – VoiceMail.....	122
IF – Timer	83	Then - LCD Keypad	123
IF - Flag	84	Then - LED Keypad.....	123
IF - Variable.....	85	Then – Security.....	124
IF – Macro.....	86	Chapter 14.	
IF – Comment	87	Power Failure	127
IF – Time.....	87	Chapter 15.	
IF - Time Label	88	Glossary of Terms.....	128
IF – Date	88	Appendix A – Lat/Long by City.....	129
IF - SunRise/SunSet.....	90	Appendix B - What is X10?.....	135
IF- ASCII In	90	X10 Addresses	135
IF- OR.....	92	X10 Theory.....	135
IF - AND.....	92	DIM/BRIGHT Limitations.....	135
IF - System Variable.....	93	Appendix C - Examples.....	136
IF - Digital Input.....	94		
IF - Analog Inputs	94		
IF - Relay State	95		
IF- IR.....	96		
IF - HVAC.....	96		

WinEVM Event Manager

WinEVM is a program for Windows based PC's and is compatible with Windows versions 3.1, Win95, Win98 and Win2000.

Before you Start

Before installing Event Manager, you should copy the distribution disks onto a set of working disks, then store the original disks for safekeeping.

Event Manager comes with an installation program that will copy the various parts of the Event Manager software onto the drives and directories that you specify. The program's menus and prompts will lead you through the install process.

Installing WinEVM:

Start Microsoft Windows.

1. Insert Setup disk in drive A.
2. Win95/98/2000: select START and choose Run.
Windows 3.1X: from Program Manager select File menu and choose Run.
3. Type a:\setup and press ENTER

A comprehensive installation/setup program will take over at this point. You will be prompted for directory information, drive, etc. Each prompt will contain default (recommended) information.

After the Install program is done, a Setup program will start to allow you to set Event Manager parameters.

Starting WinEVM:

Click on the WinEVM icon from the start menu or on your desktop.

WinEVM will start.

NOTE: If this is the first time you have started WinEVM, a message will be displayed, indicating that a device database does not exist. WinEVM will create a default database for you.

WinEVM Event Manager allows you to create a program, called a **schedule**, for your controller.

It is the user interface that runs on a Windows based PC that lets you create a **schedule** composed of multiple if-then statements called **events**. With Event Manager, you **define devices** to be used with your controller, **create and edit events into a schedule**, and **download the schedule** into the controller. These schedules are **executed** by the controller, with or without the PC connected. Only one schedule can be stored in the controller at any given time. WinEVM can also provide direct control of the controller and connected devices.

In short, the Event Manager software allows you to:

- Define and Setup Devices connected to your Controller.
- Create and Edit Events into a Schedule for your Controller.
- Download the Schedule into the Controller.
- Directly Control and Monitor Controller or attached Devices.

How Event Manager Works

The following flowchart shows the steps for creating a schedule and demonstrates how Event Manager works.

Create Device DataBase

Before you create a Schedule, you must create a Device DataBase. This tells the Event Manager what devices are in or connected to your controller. Devices may be added, changed or deleted in the Device DataBase at any time.

Create a Schedule of Events

A schedule is the list of “events” that you download to your controller. Each Event consists of an “IF” section (conditions), followed by a “THEN” section (actions). If the IF section is true, the THEN section is executed. If not, the THEN section is skipped.

Download Schedule

After a Schedule is completed, you use the download tool to transfer the schedule into the controller. Once downloaded, the controller will begin execution of the schedule.

Event Manager Screens

There are many types of Event Manager screens. The main screen will show the main menu bar, the time and date and the current schedule in the editor workspace.

The menu bar is your primary access to all the menu commands. If a menu item is followed by ” ...” , choosing the item opens another window. A menu item without the “...”, indicates that once you choose it, that action occurs.

Event Manager Windows

Most of what you see and do in the Event Manager environment happens in a window. A window is a screen area that you can move, close and open. Only one window can be active at any time.

The active window is the one that you’re currently working in. Any commands you choose or text you type generally applies only to the active window.

Event Manager makes it easy to spot the active window by highlighting the window title. If your windows are overlapping, the active window is always the one on the top of all the others (the foreground)

Controllers and Schedules

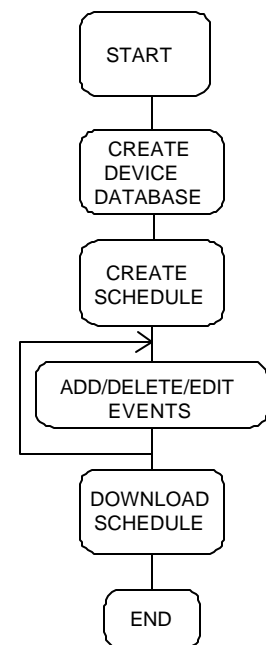

Once a controller is downloaded with a schedule, it will power-up and run the schedule continuously. WinEVM and the PC are not necessary to *run* the schedule on the controller, but can be connected to the controller PC port to allow monitoring and/or direct control of the controller and connected devices.

WinEVM Main Window is where you start working with *WinEVM* functions. You navigate *WinEVM* by the **Main Menu Bar** to open, create and edit schedules or work with the Mega Controller. The **Tool Bar** contains a subset of the most often used functions from the main menus. At the bottom of the Main Window is a Status Bar for PC related status displays.

The WinEVM Main Window looks like this:

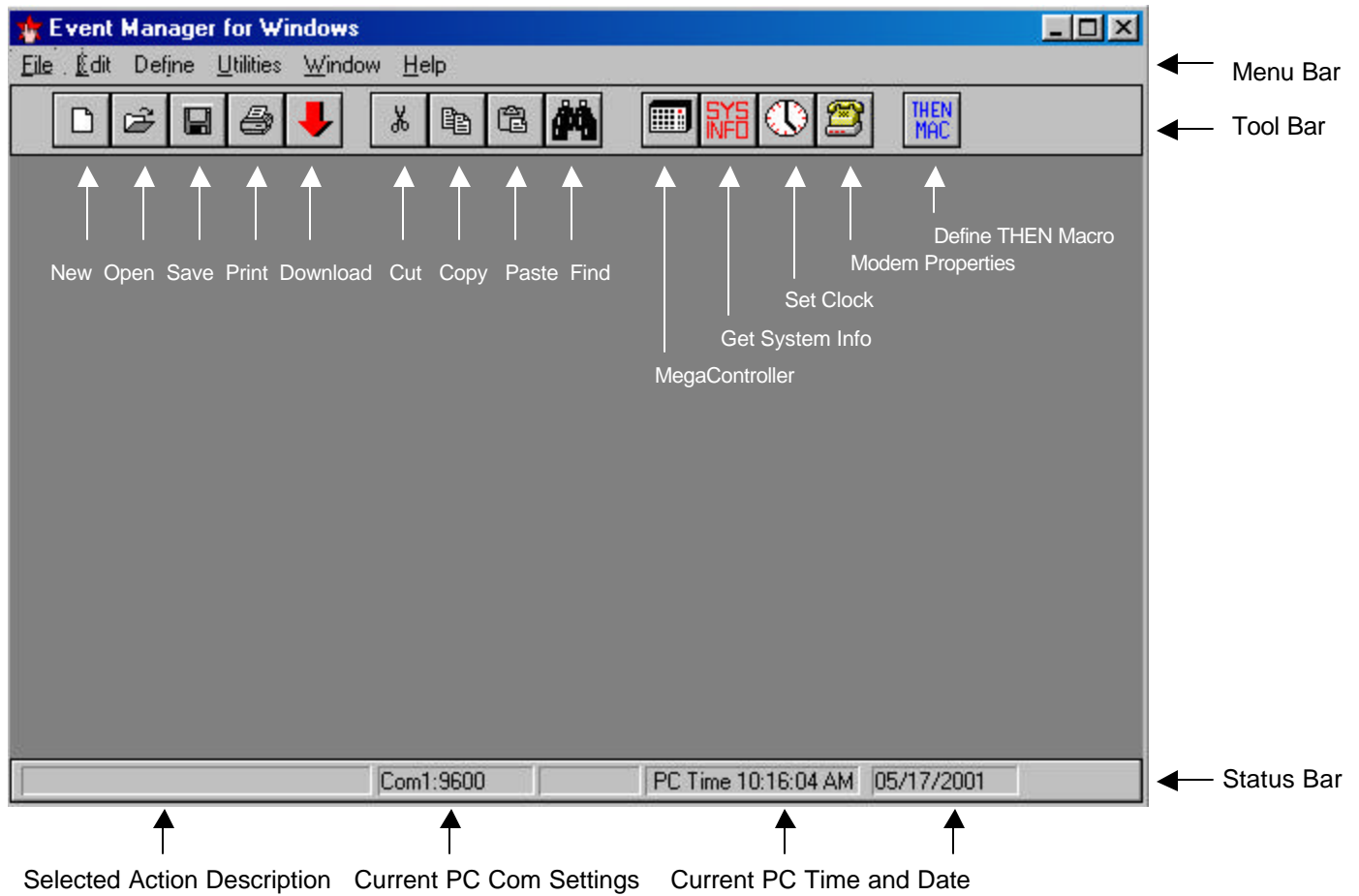

Main Menu

The WinEVM Main Menu lets you select what functions you want to use.

Select from the following on the main menu bar:

- File
- Edit
- Define
- Utilities
- Window
- Help

Each menu of the Main Menu Bar is described in detail in the following chapters.

File Menu Functions

The WinEVM Main Menu's **File Menu** lets you **Open** existing or create **New** Schedules. The menu also lets you **Save** your changes, run a **Rules Check**, **Print** the schedule, and **Download** Schedules to the controller.

File – New Schedule

The **New Schedule** command lets you open a new Schedule with the default name Untitled.sch. Event Manager will prompt you to name an Untitled Schedule when you try to save it.

File – Open Schedule

The **Open Schedule** command displays a Schedule-selection dialog box for you to select a Schedule to open into the editor workspace.

The Open Schedule box contains a schedule list and buttons labeled [OK] and [Cancel]. Once you've selected the schedule you want to open and load into Event Manager, choose the [OK] button (choose [Cancel] if you change your mind). You can also press <Enter> once the schedule is selected, or you can double-click the schedule name with the left mouse button.

File – Save Schedule

The **Save Schedule** command lets you save the current Schedule to a file in the directory that you started Event Manager in. If the schedule has the default name (Untitled.sch), Event Manager will open the **Save Schedule** dialog box to let you rename and save as a different name.

Event Manager will save the Schedule with the '.sch' file extension. If a Schedule that is being saved already exists in the directory that you are in, Event Manager will rename the old version with a '.bak' file extension.

File - Save Schedule As

The **Save As** command lets you save the schedule in the Editor workspace under a different name. When you choose this command, you see the Save As dialog box.

File - Rules Check

The **Rules Check** command will check for any errors in the current Schedule. The types of errors that will be checked are:

- Use of a Device that is not in the **Device DataBase**
- Empty Events
- Illegal combination of Conditions and Actions

A window will pop-up giving you a description of the error, and the line number that it occurs on.



Note: When viewing a schedule, errors will be shown in RED.

File – DownLoad

The **DownLoad** command lets you DownLoad the current schedule as well as initial Device settings.

You have the option of downloading your Device's Initial States as defined in the 'Define Device' menus. If you do not want to change the states of the devices that have been updated by the controller, do not select this checkbox.

What is it If you create a new Schedule or change one, it **must** be downloaded before it can be used. The Download option will download the schedule that is currently in the workspace.

How Used Select the checkbox for the Download option that you want. If you want to download the Schedule, select the Schedule checkbox. If you want to download the Initial Device States, select that checkbox.

<u>Menu Choices</u>	<u>Description</u>
---------------------	--------------------

Save Schedule to Disk	Selecting this checkbox will save the Schedule and Device DataBase before downloading.
------------------------------	---

Download Schedule	Selecting this checkbox will download the current Schedule. Before the Schedule is downloaded, a Rules Check is automatically performed. If there are any errors, you will be asked to use the Schedule Rules Check option to get more details. After the Schedule is downloaded, there will be a slight delay while the controller is preparing the Schedule to run.
--------------------------	--

Download Device Database	This option is useful for forcing all of your X10 devices to a known state before the Schedule is loaded. This option will take more time if you have a large amount of X10 devices in your DataBase.
---------------------------------	---

Note: *You cannot download a Schedule that has errors!*

File – Print

The **Print** command lets you print the contents of the current Schedule.

<u>Menu Choices</u>	<u>Description</u>
---------------------	--------------------

Initial Form Feed	Selecting this checkbox will send a Form Feed command to your printer before printing.
--------------------------	--

Line Numbers	Selecting this option will add line numbers to the Schedule when it is printing.
---------------------	--

Schedule Listing	Selecting this checkbox will print the Schedule that is active in the workspace.
-------------------------	--

Device Listing	Selecting this checkbox will print out the Device DataBase .
-----------------------	---

Print to File	Selecting this checkbox will print to a File instead of the Printer.
----------------------	--

Setup	Selecting this button will open a dialog box in which you can choose print options.
--------------	---

<u>Menu Choices</u>	<u>Description</u>
---------------------	--------------------

Print using CSV Format This option will print the **Device DataBase** using the CSV (comma separated variable) format, which can be used by many popular spreadsheet programs.

Suppress Nesting Bars If selected, the nesting bars of the Nested IF/THENs will be printed.

File – Print Schedule

The **Print Schedule** command will print out the current open schedule.

File – Exit

The **Exit** command closes WinEVM and exits to Windows. If there are any changed Schedules that you have not saved, Event Manager will prompt you to save it. The Device and Macro DataBase will also be saved if any changes have been made. These are saved into the files device.dbf and macro.dbf, the old versions being renamed device.bak and macro.bak.

EDIT Menu Functions

The WinEVM Main Menu's **Edit Menu** allows you to performing editing functions on a Schedule. You can **Cut, Copy, Paste, Find, Freeze** and **Thaw** selected lines in the Schedule.

Selecting Items to Edit

To tag the item(s) in your schedule that you want to work with, you select the lines. You can select lines a variety of ways using the mouse or the keyboard.

The selected lines in your schedule are called the *selection* and are marked on your screen with a different background color.

You can use the following techniques to select any line or series of lines in your schedule.

1. Point to where you want the selection to begin, hold down the left mouse button, and drag the mouse pointer to where you want the selection to end.

-Or-

2. Position the highlight bar where you want the selection to begin. Hold down SHIFT as you use the arrow keys to move the highlight bar to where you want the selection to end.

Edit – Cut

Lines that are Cut from a schedule are first copied into the Clipboard and then removed from the schedule.

Moving and Copying lines using the Clipboard

Lines that you cut or copy are placed in the Clipboard, a temporary storage area. A line placed in the Clipboard remains there until you choose the Cut or Copy command again, when it is replaced with the new item. You can paste an item from the Clipboard into your schedule as many times as you like. The following instructions tell how to move and copy lines:

1. Select the lines or Event
 2. To move lines, choose Cut from the Editor menu or press Ctrl-X on the keyboard.
- OR-
1. To copy lines, choose Copy from the Editor menu or press Ctrl-C on the keyboard.
 2. Position the highlight bar in a new location.
 3. From the Editor menu, choose Paste or press Ctrl-V on the keyboard.

Edit – Copy

Selected lines are copied into the Clipboard.

Edit – Paste

Lines that have been Cut or Copied into the Clipboard are Pasted into the schedule at the point that the highlight bar is positioned.

~~Edit – Select All~~

Selects all lines in schedule.

Edit – Find

Allows you to specify a text string to find in the schedule. The first occurrence of the specified text from the current cursor position will be displayed.

Edit – Next

Finds next occurrence in the schedule of the text string specified.

Edit – Freeze

Any line or lines that are selected will become 'Frozen'. This is similar to commenting out a line or using a 'REM' statement in a batch file. Any line or lines that are Frozen will not be downloaded.

Edit – Thaw

Any line that is selected and 'Frozen' will be 'Thawed' with this command. This is the opposite of the 'Freeze' command.

Note: *if you use these commands to Freeze or Thaw a line or lines, you must re-download your schedule for the changes to take effect.*

DEFINE Menu Functions

The WinEVM Main Menu's **Define Menu** allows you to define devices in your system. You must create a device database before creating a Schedule. This DataBase contains all the Devices, Timers, Variables and Flags to be used with the controller. Once a device has been created it can be used in any Schedule.

Creating the Device Database

Use the Define Menu to select and setup the devices you want to control or interface to in your system. In addition to devices, this menu lets you define other important system parameters such as, Timers, Time Labels, Flags, Variables, Macros, IR, I/O, HVAC, Telephone and Voice. Remember that this manual covers all devices supported by all the controllers this program is designed to work with. Be sure to determine if your controller can support the device selected.

Note: Event Manager can only handle 1 Device DataBase, and all Schedules created will use this Device DataBase. If you need to have a different Device DataBase, for example, if you have another home or customer that has different Device needs, create another directory and copy all the files from the WinEVM directory.

Define - X10 Device

The **X10 Device** selection will open the X10 Device List window. This window allows you to create, edit and delete X10 devices in the Device DataBase. An X10 device can be a lamp or appliance module, an X10 remote or any device that can send or receive X10 commands. (For more information on X10, see Appendix B)

Creating a New X10 Device

In the **X10 Device List** window, type or select as required for each X10 device:

- | | |
|----------------------|--|
| NAME: | Enter the device name to refer to (e.g. Living Rm Light). |
| DESCRIPTION: | Enter a brief device description (e.g. reading light). |
| LOCATION: | Enter the devices location (e.g. Living Room). |
| ENABLED: | Check this box to enable the use of the device in a schedule. |
| INITIAL STATE | Enter the default state for the device to assume when downloading the device database. Drop down selection from the following: <ul style="list-style-type: none">• No Change• ON• OFF• IDLE |

- TYPE:** Select the type of X10 module to be controlled.
- **LAMP:** Dimmer-type modules, X10 and PCS
 - **CONTROLLER:** Transmitter type devices
 - **APPLIANCE:** On/Off only type modules
 - **LAMP-EXCODE:** Leviton 6381 SAN020 models (or equivalent modules that respond to the Extended Code commands).
- POWER FAIL CATCHUP:** Check this box to force the device into its scheduled state when power fails and is then restored.
- REFRESH MODULE:** Check this box to periodically issue the X10 on or off command that corresponds to state currently stored in the controller's memory.
- VOICE REPSONSE:** Voice response given when using the TouchTone access. Each module can be assigned up to 2 words for a response.

After completing the list, press **[OK]** to store the information into the DataBase, **[APPLY]** to send the options to the controllers memory, **[CANCEL]** or **<ESC>** to return without storing.

Note 1: Only one X10 Device can be defined for a HouseCode/UnitCode address. X10 Device names must be unique, meaning, you cannot use an X10 Device name more than once.

Note 2: You must select "Download Device Database" when downloading for any of the Refresh, Catch-up or Enable options to take effect, OR, press the **[APPLY]** button to send options without downloading.

Define - Timers

Timers are countdown timers, meaning if you load one with a time, it will start to count down to zero. Timers can be loaded with a value, started and stopped from within a schedule. Each Timer counts down in 1-second intervals and can be loaded with a maximum time of 18:12:16 (18 hours, 12 minutes, 16 seconds).

<u>Menu Item</u>	<u>Description</u>
Name	The Timer name that will be used in the schedule (required)
Description	Brief description of the Timer (optional)

Define - Time Labels

A Time Label is a time with a descriptive name given to it. An example would be assigning the time 7:00 AM to the name "Wakeup". Your schedule can now refer to "Wakeup" anywhere that 7:00 AM would be used. If you need to change a time that is used often in your schedule, it would be useful to use a Time Label. This way, when you change the time in the Time Label, all references to that label will change.

Time Dependent/Offset Labels

A more powerful feature of Time Labels is the Time Dependent/offset capability. This capability allows a time to be based upon another time. An example would be assigning a time to be 30 minutes after SunSet and used to turn on exterior lighting. Since SunRise and SunSet are recalculated everyday, this Time Label would always be 30 minutes after SunSet.

<u>Menu Item</u>	<u>Description</u>
Name	Time Label name that will be used in the schedule
Description	Brief description of the Time Label (optional)
Dependent	Select whether this will be dependent upon another time. If YES is selected, a listbox showing all the defined Time Labels and an Offset time field will be shown. If NO is selected, you must fill in the time that this Time Label will refer to.

Creating a New Time Label

1. In the Time Labels window, select the [New] button. Event Manager opens the Time Label Definition window.
2. Complete the Name and Description fields.
3. Select whether this Time Label will be dependent upon another time by pressing the appropriate YES/NO radio button.

IF YES - dependent on another time

- a) Move the highlight bar onto the Time that this Time Label will be dependent upon
- b) Select whether time will be added or subtracted from the selected Time Label.
- c) Enter the amount of time that will be added or subtracted. The maximum time that can be added or subtracted is 4 hours 15 minutes, (4:15). The offset time combined with the Time Label cannot be greater than 23:59 or less than 00:00, meaning the combined time cannot carry over into the next or previous day. This will not cause an error condition, but the IF statement will never be true.

IF NO - not dependent on another time

- a) Enter the Hour and Minutes and select the days that will be assigned to this Time Label
 - b) Select whether this Time Label will use the Security feature.
4. Select the [OK] button to accept your choice and store the Time Label into the Device DataBase, or [CANCEL] to quit without storing.

Note: *You can't use the same name for more than one Time Label.*

Editing an Existing Time Label

1. In the Define Time Label window, move the highlight bar to the Time Label that is to be edited and select the [EDIT] button.
2. Make changes to the Time Label.

Select the [OK] button to accept your choice and store the Time Label into the Device DataBase, or [CANCEL] to quit without storing.

Note: You will be asked to confirm your choice if you change the name of a Time Label that is used in the current schedule.

Deleting a Time Label

1. In the Define Time Label window, move the highlight bar to the Time Label that is to be deleted.
2. Select the [DELETE] button.

Define - Flags

A Flag is a variable that has three states: Set, Clear or IDLE. Any Event can set or clear a flag as well as check the state. Flags are useful for communicating between Events or assigning a global variable such as 'Alarm Armed'.

<u>Menu Item</u>	<u>Description</u>
Name	The Flag's name that will be used in the schedule
Description	Brief description of the Flag (optional)
Initial State	This will be the initial state that this flag will be set to if the DownLoad Device DataBase option is selected when downloading the schedule.

Define - Variables

A Variable can have a value that ranges from 0 to 255. Variables can be incremented, decremented, loaded with a value and cleared. Variables are useful when you need to base decisions on reoccurring conditions. An example would be to count the number of times the motion sensor at your front door was activated. This would tell you how many people came to your front door.

<u>Menu Item</u>	<u>Description</u>
Name	The Variable's name that will be used in the schedule (required)
Description	Brief description of the Variable (optional)
Initial Value	This will be the initial value that this Variable will be set to if the DownLoad Device DataBase option is selected when downloading the schedule.

Define - IF Macros

An IF Macro is a series of IF conditions, and the logic type associated (AND/OR). The IF conditions are entered into the Macro the same way as Events. Each IF Macro can be used in your Schedule any number of times.

IF Macros are useful for when you use the same set of IF conditions in more than one Event. By defining a set of IF conditions as an IF Macro and replacing those repeated conditions, you can reduce your schedule size and make it more readable. When an IF Macro is used in an Event, the conditions within the macro must be met for the IF Macro to be true.

Example 6.1 IF Macro named 'Dark Weekdays'.

```
MACRO BEGIN
If
    After SunSet .MTWTF.
    or Before SunRise .MTWTF.
MACRO END
```

Example 6.2 Embedded IF MACRO.

```
EVENT: Good Morning
If
    IF MACRO(Dark Weekdays)
Then
    (X:PorchLight A 2) ON
End
```

In this example, if the IF Macro "Dark Weekdays" is TRUE, (that is, if it after SunSet OR before SunRise on weekdays), THEN turn the Porch Light ON.

Creating a New IF Macro

1. In the Define IF Macro window, select the [New] button. Event Manager opens the IF Macro Definition window.
2. Complete the Name, Description and Logic Type fields.
3. Add IF Conditions by using the ToolBox.
3. Select the [OK] button to accept your choice and store the IF Macro into the Device DataBase, or the [Cancel] button to return without saving.

Note: You can't use the same name for more than one IF Macro.

Editing an Existing IF Macro

1. Highlight the IF Macro that you want to edit and select the [EDIT] button.
2. Change or Add IF Conditions by using the ToolBox.
3. Select the [OK] button to accept your choice and store the IF Macro into the Device DataBase, or the [Cancel] button to return without saving.

Deleting an IF Macro

1. Highlight the IF Macro that you want to delete.
2. Press the [DELETE] button on your keyboard.

Define - THEN Macros

A THEN Macro is a series of THEN actions. The THEN actions are entered into the Macro the same way THEN and ELSE actions are in the Event Editor. Each THEN Macro can be used in a Schedule any number of times. Then Macros can contain Nested IF/THEN structures and calls to other THEN Macros.

THEN Macros are similar to IF Macros, except they use action statements instead of condition statements. THEN Macros are useful when you use the same set of actions over and over in different Events.

Example 6.3. THEN Macro named 'Lights Off'.

```
MACRO BEGIN
  (X:Study Lamp A 7) OFF
  (X:Radio A 12) OFF
MACRO END
```

Example 6.4. Event using a THEN Macro.

```
EVENT: Good Night
If
  11:00 PM SMTWTFS
Then
  (THEN MACRO:Lights Off)
End
```

In this example, if the time is 11:00 PM on any day, the Study Light and Radio will be turned off.

Creating a New THEN Macro

1. In the Define THEN Macro window, enter a name for the macro in the name field and then press the EDIT button. Event Manager opens the THEN Macro Definition window.
2. Add THEN Actions by using the ToolBox tools.
3. Select the [OK] button to accept your choice and store the THEN Macro into the Device DataBase.

Note: You can only have one THEN Macro with a given name.

Editing an Existing THEN Macro

1. In the Define THEN Macro window, move the highlight bar to the THEN Macro that you want to edit and select the [EDIT] button.

Deleting a THEN Macro

1. Highlight the THEN Macro that you want to delete.
2. Press the [DELETE] button.

Define – IR and IO Devices

** On Board I/O or I/O Expander Options **

To define an IR or IO device select the **IR and IO Devices** menu from the Define main menu. .

You must have a controller with on-board I/O or an I/O Xpander.

If you have a RS485 Network I/O device do not use this menu. Select the device directly from the DEFINE menu.

Select IR or I/O device.

Select the **IR and IO devices** menu from the Define menu. This screen will give you the option to select an IR Xpander device, a controller's On board I/O or one of four I/O Xpander devices (1-4).

To Enable the IR or IO device to be used, select the Enable checkbox next to the device. When the OK button is pressed, the enable information is sent to the controller and stored in non-volatile memory. The controller uses this to determine which devices to read and write to. Be sure to “define” the device before leaving this window.

Device Setup



To define the selected device, double click on the device or highlight the device and select [Define] button. A Setup Dialog window will open. When setting up the IO-Xpander, select the address that matches the dipswitch address on the IO-Xpander.

IR Setup

When you select the IR device, an IR setup window will open. See the IR Xpander documentation to set up this device.

IO Setup

When you select an IO device, the IO setup window shown below will open. Enter names for each IO connection. Each name corresponds to an input or output on the controller or IO-Xpander. When completed, click [OK] to Exit. More information on the analog section and calibration is covered in the next section.

Opto Inputs		Relay Outputs		 
Opto 1	Z1-FrontDr	Relay 1	Siren	
Opto 2	Z2-Ext Gr Dr	Relay 2	Beeper	
Opto 3	Z3-Int Gr Dr	Relay 3	Relay3	
Opto 4	Z4-Offic WIn	Relay 4	Relay4	
Opto 5	Z5-Slide Dor	Relay 5	Relay5	
Opto 6	Z6-FamRm WIn	Relay 6	Relay6	
Opto 7	Z7-Kitch WIn	Relay 7	SB Relay1	
Opto 8	Z8-DinRm WIn	Relay 8	SB Relay2	
Opto 9	Z9-LivRm WIn			
Opto 10	Z10-MsBd WIn			
Opto 11	Z11-MsBdDoor			
Opto 12	Z12-MsBathWIn			
Opto 13	Z13-Bdm1 WIn			
Opto 14	Z14-Bdm2 WIn			
Opto 15				
Opto 16	Z16-FmRm PIR			

Analog Inputs			
A/D 1	AD1	Calibrate	
A/D 2	AD2	Calibrate	
A/D 3	AD3	Calibrate	
A/D 4	AD4	Calibrate	
A/D 5	AD5	Calibrate	
A/D 6	AD6	Calibrate	
A/D 7	AD7	Calibrate	
A/D 8	AD8	Calibrate	

Analog Inputs

The Analog inputs connect internally to an Analog to Digital Converter that converts analog voltages into a digital representation compatible with the controller. The A/D converters are 8 bit (range: 0-255) with an input voltage range of 0-5 volts DC. This gives a resolution of approximately 20mV/bit (256 x 20mV = 5V). When the A/D input is read, it will read a value in the range of 0-255, which represents a voltage from 0-5 applied to the input. The table below shows some typical input voltages and shows what will be read.

<u>Input Voltage</u>	<u>CONTROLLER</u>
0 volt	0
1 volt	51
2.5 volt	128
4 volt	205
5 volt	255

Table 1: Analog Input Voltages

Calibrating

Calibration can be done through an external gain/offset circuit or done through software. There are tradeoffs using either method, if resolution is important the external gain/offset circuit is preferred, if resolution/accuracy is not as important (there is no general rule of thumb, each application is different and the tradeoffs must be examined on a case by case basis) the software gain/offset may be acceptable.

Lets suppose you are going to measure temperature using an AE1000 Wall plate temperature sensor. The AE1000 temperature sensor output voltage is linearly proportional to the Fahrenheit temperature (10.0 mV/degree F and has a range from +32 to +212 degrees F).

Assume the temperature being measured is 72° F. The LM34D will output 720mV (72° x 10mV/degree). This will be read this 720mV and the digital representation will be 36.

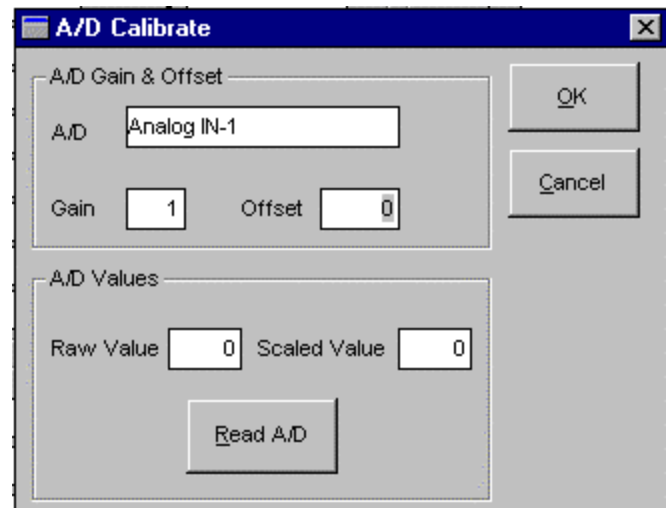

$$\text{A/D resolution-20mV/bit: } 720\text{mV} \div (20\text{mV/bit}) = 36$$

So, if the controller reads '36' when the temperature is 72°. It would be nice if the value read were the same as the temperature. The two ways of doing this could be:

1. Build a 2x amp to convert the 720mV to 1400mV (1400mV / (20mV/bit) = 72)
2. Multiply the value read by 2 (36 x 2 = 72), a gain of 2

Option 2 requires the least amount of work, but the resolution of the A/D converter is multiplied by 2 as well, going from 20mV/bit to 40mV/bit. To use the option 2 approach, the gain can be increased by software from within the **Define | IO Devices** dialog boxes. Every A/D input can be calibrated with a software gain and offset. The gain will actually multiply the A/D value and the offset will be added to the result. Using the previous AE1000 example, let's say a gain of 2 will give a value of 70 at 72 degrees. It is not 72 as would be expected due to many factors, wiring capacitance, AE1000 accuracy, etc. By specifying an offset of 2, this will bring the value in line with the temperature. The formula for scaled A/D is:

$$\text{scaled_value} = (\text{raw_A/D_value} \times \text{gain}) + \text{offset}$$

If you do not need a gain factor, be sure to set the gain to 1 and offset to 0.

Note 1: You may use Define IO anytime you add another IO Device, change connections or rename ports. Note that if you do make a change, such as swapping 2 inputs, you will need to re-download the schedule before the changes take effect.

Note 2: Connect ANALOG GROUND to GROUND when using the on-board 5VDC Power source to power analog devices.

Digital Inputs

When using Digital Inputs, be sure the jumpers are in the correct position for the application.

For applications that provide a voltage to the digital input (alarm panels, doorbells, etc.) the jumpers must be in the LEFT position (see Figure 1: Digital Input Left Position). Be sure the voltage applied to the digital input is between 4-24 volts AC or DC.

If a voltage source is needed, some controller's 12VDC POWER SOURCE may be used.

CAUTION: This Power Source is rated 12VDC @ 0.5A. USE AN EXTERNAL POWER SUPPLY IF MORE CURRENT IS REQUIRED.

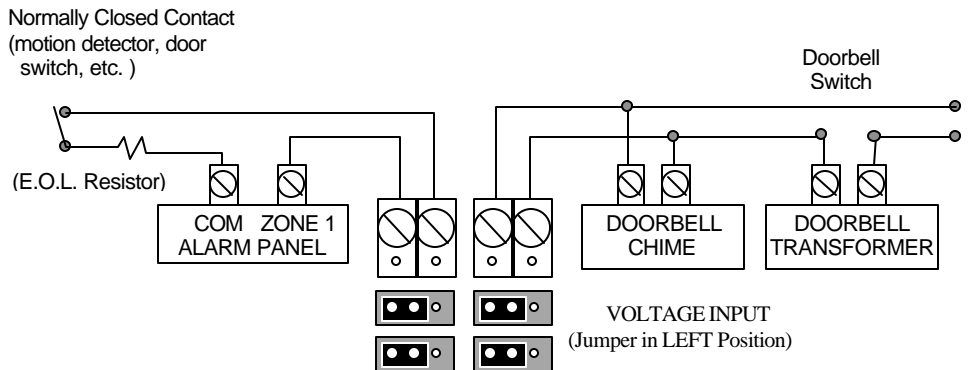

Figure 1: Digital Input Left Position

For applications that provide a “dry contact” switch closure to the digital inputs (switches, relays, etc.) the jumpers must be in the RIGHT position as shown in Figure 2: Digital Input Right Position.

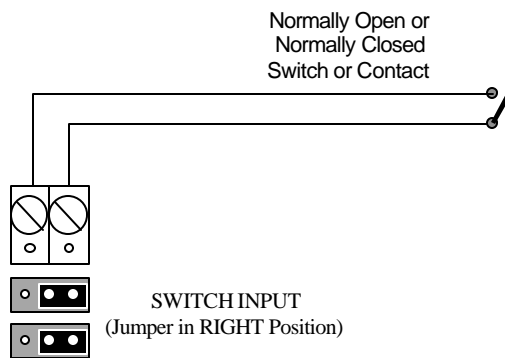

Figure 2: Digital Input Right Position

Relay Outputs

Each Relay Output has three terminals: "NO" (normally open), "NC" (normally closed), and "C" (common). The NO is connected to C when the relay is ON. NC is connected to C when the relay is OFF. In Figure 3: Relay Connections, two relays are used to allow a single-line cordless phone to switch between two different phone lines. The cordless base is normally connected to Line 1 (Relay 1 and Relay 2 de-activated). When Relay 1 and Relay 2 are both activated, it connects to Line 2.

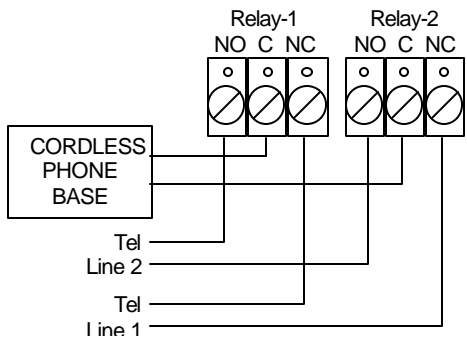

Figure 3: Relay Connections

Define - 8CH Relay

** RS485 Network Device **

8 Channel Relay Control Unit

The 8 Channel Relay board provides 8 independent SPDT relays that can be controlled through the WinEVM schedule and/or the MegaController. Each relay can be programmed to turn ON, OFF or Pulsed for a time duration.

A Status LED, located next to each Relay indicates the ON/OFF state of the relay as well as a network activity LED.

Connection to the RS485 Network.

Up to 16 Relay controllers can be connected to the RS485 Network. They can be wired by two methods.

Daisy Chain Wiring. A "daisy-chain" wire is run from the Controller's RS-485 port using two twisted pairs of category-5 cable (one pair for communication and the other for 12vdc power) to each device in series. Max cable length is 4000 feet.

Star Wiring. Each device can be connected to a RS485 star wiring hub (Model 8AH485 for an eight channel hub) for convenient "home run" star wiring. The Hub provides power and data distribution. Each home run Cat 5 wire can be 4000 Feet in length.

Configure WinEVM software:

- 1) Click DEFINE – 8CH Relay.
- 2) Select the 8CH Relay address you want to program then click DEFINE to open the programming utility.
- 3) Enter a name for the Relay Board.
- 4) Enter a name for each Relay.
- 5) Repeat step 4 for each Relay.
- 6) Click OK to exit.

Define - LCD Keypad

*** RS485 Network Device ***

LCD Keypad

The LCD Keypad is a versatile, easy-to-use, menu-driven keypad that allows control of lighting, heating/cooling, security, home theater, audio/video, pool/spa, irrigation, voice mail, and other systems connected to the controller.

Up to 96 interactive menu screens can be created and downloaded to the LCD Keypad by the user/installer with the Event Manager software.

Each of the eight lines on a menu screen can have text (up to 10 letters across) or a graphic (.bmp format, 64 x 16 pixels) to identify the rocker button to its right.

8 Dual-Position Rocker Buttons, located to the right of the menu display, can be individually programmed to perform different functions depending on the menu selected. The Left and Right side of each button can be programmed independently (such as left = off, right = on) or perform the same function (such as go to Main menu). Programmable functions include: Navigational functions (go to menu, previous menu), Then Actions (X10, IR, Relay, Macro, VoiceMail, Flag, Variable) and Predefined Menus (Thermostat, VoiceMail, TimeLabel, Caller ID, Digitpad, Keypad, Time Display).

A special two-way X10 feature allows any X10 address to be assigned to a rocker button. Pressing once on the right or left side of the button turns the X10 device On or Off. Holding down the right or left side of the button Brightens or Dims. On/Off status is indicated by a normal (Off) or reversed (On) background on the associated menu line for easy viewing, even from a distance.

Connection to the RS485 Network.

Up to 16 LCD Keypads can be connected to the RS485 Network. They can be wired by two methods.

Daisy Chain Wiring. A "daisy-chain" wire is run from the Controller's RS-485 port using two twisted pairs of category-5 cable (one pair for communication and the other for 12vdc power) to each keypad in series. Max cable length is 4000 feet.

Star Wiring. Each LED Keypad can be connected to a RS485 star wiring hub (Model 8AH485 for an eight channel hub) for convenient "home run" star wiring. The Hub provides power and data distribution. Each home run Cat 5 wire can be 4000 Feet in length.

The LCD keypad mounts into its own back box (included),

Configure WinEVM software:

- 1) Click DEFINE - LCD KEYPAD.
- 2) Select the LCD Keypad address you want to program then click DEFINE to open the LCD KEYPAD setup utility.
- 3) Click the SETUP KEYPAD button.
- 4) Enter a name and location for the keypad. Set or change the timeout parameters (if not already set at keypad). Click Apply then OK.
- 5) Click the "Select" button in the MENU SCREEN SELECT section to select the Menu number you want to program then type a name for the menu (i.e.: "MAIN") in the "Name" box.
- 6) Click on an ACTION you want to assign to a keypad button, then drag the action onto the menu screen (to the left of the desired keypad button). This will bring up an edit field for the type of action selected.
- 7) Complete the edit field then click OK to accept the action or CANCEL to escape.

Note: The left and right side of a keypad button can each be programmed to perform different actions. Click the "RIGHT BUTTON SAME AS LEFT" box when you want both sides to perform the same action.

- 8) Repeat step 6 for each button in the menu you want to program.
- 9) Click DOWNLOAD MENU to load the LCD Keypad with the new menu or select another Menu number to program and repeat steps 5- 8.

- 10) To download all defined menus to the LCD Keypad, click DOWNLOAD ALL. This may take a few minutes depending on the number of menus and content (text/graphics) being downloaded. It is not necessary to DOWNLOAD ALL menus if each menu is downloaded individually.
- 11) Click OK to exit.

~~Define~~ LED Keypad

** RS485 Network Device **

LED Keypad

The LED Keypad is a simple, easy-to-use keypad with 7 soft buttons that can be individually programmed (with the WinEVM Event Manager software) to perform any function (lighting, heating/cooling, security, home theater, audio/video, pool/spa, irrigation, etc.). A removable label can be printed on paper with any printer then inserted into the keypad's label window to clearly identify each button.

A Red LED, located to the left of each button, can be programmed to turn off, turn on steady or blink based on any condition(s) specified in the Event Manager schedule.

For example, Button #1 could be programmed to trigger the "Away" macro that turns off all the lights, sets back the thermostat and arms the alarm panel. LED #1 could blink as the controller executes the macro then turn on steady when the macro has completed to indicate "Away" mode is in effect.

Connection to the RS485 Network.

Up to 16 LED Keypads can be connected to the RS485 Network. They can be wired by two methods.

Daisy Chain Wiring. A "daisy-chain" wire is run from the Controller's RS-485 port using two twisted pairs of category-5 cable (one pair for communication and the other for 12vdc power) to each keypad in series. Max cable length is 4000 feet.

Star Wiring. Each LED Keypad can be connected to a RS485 star wiring hub (Model 8AH485 for an eight channel hub) for convenient "home run" star wiring. The Hub provides power and data distribution. Each home run Cat 5 wire can be 4000 Feet in length.

The LED Keypad fits into a standard single-gang box (not included).

Configure WinEVM software:

- 1) Click DEFINE - LED KEYPAD.
- 2) Select the LED Keypad address you want to program then click DEFINE to open the LED KEYPAD programming utility.
- 3) Enter a name for the keypad.
- 4) Enter a name for each button.
- 5) Select what the button controls, an X10 device or triggering a Then Macro.
- 6) Select the X10 device or Then Macro.
- 7) Repeat steps 4-6 for each button
- 8) Click DOWNLOAD to load the LED Keypad with the new information.
- 9) Click OK to exit.

Define - HVAC

* X10 or RS485 Network Device *

Defining HVAC Thermostats is done by selecting **HVAC** in the Define Menu. The Setup Window opens allowing you to select and setup Thermostats, Temperature Sensors and Zone Controllers.

Setup as follows:

1) Select the Zone number, 32 HVAC zones are available.

2) Assign the Zone a name.

3) Select the Thermostat Type.

- X10 thermostat
- RS-485 thermostats

4) Set address

- X10 – House Code
- RS485 - network address.

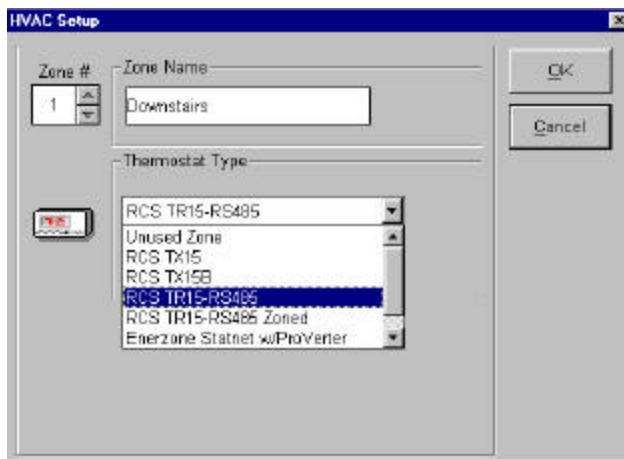

Define - Telephone

* Telephone/Voice Option *

The **Telephone** parameters setup menu lets you setup all the operational telephone parameters. Click on **DEFINE** then click on **TELEPHONE** to bring up the Telephone Parameters Setup menu. **Requires the Telephone/Voice option to be installed.**

Touchtone To X10 Mode

Some controllers support several formats of touchtone-to-X10 control.

90 Code - mode allows control of 90 X10 addresses using * (for ON) or # (for OFF) followed by two digits (similar to TeleCommand System 100). Defaults = House codes A-J, Key codes 1-9 and All Lights On/All Units Off/Dim/Bright.

160 Code - mode allows control of 160 X10 addresses using * or # followed by three digits. Defaults = House codes A-J, Key codes 1-16 and All Lt. On/All Units Off/Dim/Bright.

NONE - mode disables touchtone-to-X10 control. This is useful for applications that require customized TouchTone control, which is programmed specifically for each event.

X10 Mapping

Clicking on the **X10 Mapping** button brings up the **TouchTone to X10 Mapping Menu**. This menu lets you "map" TouchTone codes to any X10 command.

TouchTone Code - The TouchTone number dialed.

House Code - The associated X10 letter code.

Key Code - The associated X10 number code.

Name (from dbf) - The associated X10 device name.

Local On Restrict - Checking this box prevents the corresponding TouchTone code from issuing the associated X10 On command when dialed from an on-premise phone.

Local Off Restrict - Checking this box prevents the corresponding TouchTone code from issuing the associated X10 Off command when dialed from an on-premise phone.

Rem1/Rem2/Rem3 On Restrict - Checking this box prevents the corresponding TouchTone code from issuing the associated X10 On command when dialed remotely using Remote Access Code 1, 2 or 3.

Rem1/Rem2/Rem3 Off Restrict - Checking this box prevents the corresponding TouchTone code from issuing the associated X10 Off command when dialed remotely using Remote Access Code 1, 2 or 3.

Local Access

Intercom Access Code - Dialing this code will switch all telephones connected to the "PHONE" output jack to the internal intercom. Default = *01.

TAD Bypass Code - When an external Telephone Answering Device (TAD) is used, dialing this code when calling in will override the answering device to allow access to the controller.

Enable-Disable Code - Dialing ### followed by this code will DISABLE TouchTone to X10 control (90 or 160 mode). Dialing *** followed by this code will ENABLE TouchTone to X10 control (90 or 160 mode). This is useful to prevent inadvertent operation of X10 devices when using phone company services that require dialing * or #.

HOLD Code - Dialing * followed by this code will place the C.O. line on hold. Dialing # followed by this code will release hold.

Caller ID Enable

Check this box to enable Caller ID recognition.

Area Code – Enter your locations Area Code. Used to prevent announcing the Area Code for local calls when announcing a Caller ID number.

Remote Access

Remote Access – Select this button to go to the VoiceMail/Remote Access setup screen.

Ring Command Code

On/Off - Turns Ring Command code feature on or off.

House Code/Unit Code - Select the desired X10 code to be transmitted when the phone rings.

Send Ring On - If selected, only the X10 ON code will be transmitted each time the phone rings.

Send Ring Off - If selected, only the X10 OFF code will be transmitted each time the phone rings.

First Ring Only -If selected, the selected X10 code will be transmitted on the first ring only.

Telephone Time Settings

Hookflash - Defines the time duration of a hookflash generated (default = 600 milliseconds).

Comma Delay - Defines the time duration of a pause generated when a comma is used.

Phone Input

C.O. Access - Defines the default state of the "PHONE" jack (C.O. line or Intercom).

If **Intercom** is selected, picking up any phone connected to the "PHONE" jack will first access the intercom. If the associated C.O. Access code is dialed (default = 9), the phone will switch to the C.O. Line (similar to a PBX system). Hanging up will reset the PHONE jack back to intercom mode.

Define - VoiceMenu/VoiceMail

*** Telephone/Voice Option ***

The VoiceMenu/VoiceMail is an integrated system that provides a high level of features and functionality not found in Telephone Answering systems. The VoiceMenu/VoiceMail interface is composed of 2 separate but tightly coupled parts, VoiceMail and VoiceMenu. **Requires the Telephone/Voice option to be installed.**

VoiceMail

Voice Mail is the interface the caller uses when calling in. Functions include basic Telephone Answering Machine functions such as leaving messages in the main voice-mailbox or any of seven secondary voice-mailboxes. The first three voice-mailboxes have access to the full VoiceMenu functionality; the remaining five voice-mailboxes have access to the VoiceMail submenu of the VoiceMenu structure only. The VoiceMail system can be setup as a single voice-mailbox system or as a multiple voice-mailbox system with the main outgoing message providing directions for leaving a message in a secondary voice-mailbox.

VoiceMenu

Voice Menu is the interface the caller uses to access the controller system to retrieve messages, control HVAC or security, or any custom function. Once the proper password is entered, the caller has access to all of the defined VoiceMenu functions.

Memory

There is approximately 45 minutes of total voice storage available for VoiceMail and VoiceMenu messages and user voice responses.

Programming the VoiceMail System

8 voice-mailboxes are supported. Each mailbox has a password and Greeting (Outgoing Message). Each Greeting uses one of the 128 User Defined Voice responses. Each mailbox can record up to 255 incoming messages each (stored in dedicated memory locations).

VoiceMail Mailboxes are accessed remotely through the Voice Menu interface. The Voice Menu provides a basic framework for sophisticated Interactive Voice Menus.

Single User VoiceMail System

A Single User mailbox system uses "Main 1" Mailbox only and has a single password for gaining access into the system. This system most closely resembles a standard answering machine where someone calls in, hears a Greeting and then leaves a message. To setup a Single User mailbox follow these steps:

- 1) Click *Define*, then click *VoiceMail/Remote Access*.
- 2) Select *VoiceMail & VoiceMenu System* in the Access Mode section.
- 3) Set *Answer On Ring* to the number of rings the system should count before answering incoming calls.
- 4) Set the *Remote Timeout* time. During the playback of messages, if the number of seconds entered elapses with no Touch-Tone activity, the system will hang up.

- 5) Select the *Maximum Record time* in the VoiceMail section. This is the maximum time an incoming message can be recorded before the system hangs up.
- 6) Set the desired *Incoming Call Monitor* output if you want to listen to messages as they are being left.
- 7) Check the *Enable* Checkbox for Mailbox "Main 1" only. UN-check all other *Enable* Checkboxes.
- 8) Click on the *Password* cell for Mailbox "Main 1" then enter a password (up to six digits).

Recording the Greeting (Outgoing Message)

This greeting will be played when the system answers incoming calls. The Greeting uses one of the 128 User Voice Responses. The Greeting can be selected through the schedule to allow different Greetings based on time of day, day/night, weekends, etc.

- 9) Double-click the *Greeting* cell for Mailbox "Main 1." This will take you to the *Voice Mail Greeting/User Voice Response* window.
- 10) Select any blank line in the *User Voice Response* list and type in a name such as "Main Greeting" or "O.G.M."
- 11) Select the appropriate *Record Source*.
- 12) Click the *Record* button and record the Greeting. Then click the *Stop* button.
- 13) To review the Greeting, select the appropriate *Playback Test* output then click the *Play* button. If necessary, repeat step 12 and 13 until you are satisfied with the greeting.
- 14) Click the *OK* button.

Running a Macro after a Message is left in Mailbox

A THEN Macro can run after a message has been left in a mailbox. This is useful for notifying a pager of a new message, or calling another number. To run a THEN Macro after a message is left in a mailbox:

- 15) Check the *Enable Macro* checkbox for Mailbox "Main 1".
- 16) Double-click the *Macro To Run After Message* cell for Mailbox "Main 1" then select from the list of defined THEN Macros, then click *OK*.

Click the *APPLY* button to download the information. At this point you should be able to place a call, hear the Greeting, and leave a message.

Multiple User VoiceMail System

A Multiple User mailbox system can have up to 8 voice-mailboxes. A typical application for a Multiple User Mailbox would be a family or small business that does not want to share a common answering machine so that each family member or employee can have a private mailbox.

Mailbox "Main 1" is the starting point for all incoming calls. This Greeting should instruct the caller how to leave a message in the personal mailboxes (2 - 8). A typical Mailbox Main 1 Greeting would be: "You have reached the Smith residence, to leave a message for Tom press 2, to leave a message for Jane press 3, to leave a message for Tim press 4, or leave a general message at the beep". In this example, Mailbox 2 is assigned to Tom, 3 to Jane and 4 to Tim. The caller wanting to leave a message for Tom, presses 2. Tom's Greeting (Mailbox 2) will start playing, "Hi this is Tom, sorry I'm not here to take your call. Please leave a message at the beep". The message will be recorded into Tom's Mailbox.

To setup a Multiple User mailbox follow these steps:

- 1) Click *Define* then click *VoiceMail/Remote Access*.
- 2) Select *VoiceMail & VoiceMenu System* from within the Access Mode box.
- 3) Set *Answer On Ring* to the number of rings the system should wait before answering incoming calls.
- 4) Set the *Remote Timeout* time. During the playback of messages, if the number of seconds entered elapses with no Touch-Tone activity, the system will hang up.
- 5) Select the *Maximum Record time* in the VoiceMail section. This is the maximum time an incoming message can be recorded before the system hangs up.
- 6) Set the desired *Incoming Call Monitor* output if you want to listen to messages as they are being left.
- 7) Check the *Enable* Checkbox for the Mailboxes used only. UN-check all other *Enable* Checkboxes.
- 8) Click on the *Password* cell for each mailbox and enter a different password (up to six digits) for each.

Recording the Greeting (Outgoing Message)

This greeting will be played when the system answers incoming calls. This Greeting should instruct the caller what digit to press in order to leave a message in the appropriate Mailbox. Example: “*You have reached the Smith residences, to leave a message for Tom press 2, to leave a message for Jane press 3, to leave a message for Tim press 4, or leave a general message at the beep*”. Each Mailbox’s Greeting uses one of the 128 User Voice Responses. A Mailbox’s Greeting can be selected through the schedule to allow different Greetings based on time of day, day/night, weekends, etc.

- 9) Double-click the *Greeting* cell for Mailbox Main 1. This will take you to the *Voice Mail Greeting/User Voice Response* window.
- 10) Select any blank line in the *User Voice Response* list and type in a name such as “Main Greeting” or “O.G.M.”
- 11) Select the appropriate *Record Source*.
- 12) Click the *Record* button and record the Greeting. Then click the *Stop* button. When using multiple mailboxes, allow several seconds of silence before clicking the stop button to give the caller time to make a selection. If a selection is not pressed, a beep will be heard and the caller’s message will get recorded into general mailbox 1.
- 13) To review the Greeting, select the appropriate *Playback Test* output then click the *Play* button. If necessary, repeat step 12 and 13 until you are satisfied with the greeting.
- 14) Click the *OK* button.
- 15) Repeat steps 9 - 13 for the other (personal) voice-mailboxes used. Keep in mind that these Greetings should each be a personal Greeting for the Mailbox owner. Example: “*Hi this is Tom, sorry I’m not here to take your call. Please leave a message at the beep*”

Running a Macro after a Message is left in Mailbox

A THEN Macro can run after a message has been left in a mailbox. This is useful for notifying a pager of a new message, or calling another number. To run a THEN Macro after a message is left in a mailbox:

- 15) Check the *Enable Macro* checkbox for the desired mailbox.
- 16) Double-click the *Macro To Run After Message* cell for the desired mailbox then select from the list of

defined THEN Macros, then click *OK*.

Click the *APPLY* button to download the information.

At this point you should be able to place a call, hear the Main 1 Mailbox Greeting, press a digit to go to another Mailbox, and leave a message.

Programming the VoiceMenu System

The VoiceMenu system provides remote access to retrieve messages and control the system. The VoiceMenu provides a framework for a sophisticated Interactive VoiceMenu structure.

Eight (8) VoiceMenu menus are available, each menu having 10 touch-tone digit choices. Pressing a touch-tone digit can trigger a Macro, go to another VoiceMenu, perform a VoiceMail function, go to Command mode, or disconnect the call.

A typical call into the controller to retrieve messages would be:

1. Call the number the controller is connected to.
2. When it answers and plays the Greeting, press the pound digit (“#”) to stop the Greeting.
3. Enter the password for the Mailbox (defined in the VoiceMail setup)

it will respond with “You have [number] (new) messages in Mailbox [number]”

At this point you are in the “MAIN” VoiceMenu menu. The VoiceMenu Prompt defined for “MAIN” will begin to play.

4. Press 2 to go to the VoiceMail menu.
5. Press 1 to play the 1st Message left in the Mailbox

To setup the VoiceMenu System, follow these steps:

- 1) Click *Define* - then click *VoiceMail/Remote Access*.
- 2) Select *VoiceMail & VoiceMenu System* in the Access Mode section.
- 3) Select the *MAIN* tab in the VoiceMenu section.
- 4) Press the *Edit* button to create a Main VoiceMenu Prompt list. This is the prompt you will hear when you enter the password for your mailbox (after the number of messages is announced). Each VoiceMenu Prompt list can contain a combination of up to 60 Preset words, phrases, sound effects, and/or User Voice Responses. Double-click on each Word, Phrase, Sound, or User Voice Response to build your Main VoiceMenu Prompt list then click *OK*.
- 5) To the right of the VoiceMenu Prompt is a grid showing *TouchTone Digits* 1 through 0, each with an associated *Action*. When a TouchTone Digit is pressed, the Action is executed. Double click on the *Action* cell for each digit then select the appropriate *Voice Menu Action* (Do Nothing, Do Macro, Go to Menu, VoiceMail, Go to Command mode, or Hang up).

Do Nothing: Nothing will happen when this Digit is pressed.

Do Macro: A THEN Macro will be triggered when this Digit is pressed. Macros can perform complex functions such as changing Temperature SetPoint, Arming Security systems or reporting status. Macros must first be defined before they can be selected. To define a THEN Macro, click the THEN MACRO icon on the Button Bar at the top of the screen.

Go to Menu: Go to a VoiceMenu when this Digit is pressed. This command is used to move between the different Voice Menus. A simple way to replay the current VoiceMenu Prompt is to choose the same VoiceMenu that you are in.

VoiceMail: Trigger a VoiceMail command such as Play, Delete, Replay, etc.

Go to Command Mode: This will take the controller out of VoiceMenu Mode and into Command Mode. Command Mode allows the use of the TouchTone to X10 (i.e., *11 to turn A-1 ON).

Hang Up: Disconnects (goes on-hook).

Repeat steps 3 - 5 for each VoiceMenu Tab.

6) Press the *APPLY* button to download the information. At this point you should be able to place a call, enter a Password and gain access to the VoiceMenu System.

Note: You can also access the VoiceMenu system locally by switching to Intercom and entering the password.

Accessing the VoiceMenu/VoiceMail System

There are 4 methods to access the VoiceMenu/VoiceMail system:

Remote Access

Calling and entering one of the passwords will place the user into the VoiceMenu system. Only the first three mailboxes (Main1, 2 & 3) have access to the full VoiceMenu system, the other five mailboxes (4-8) have access to the VoiceMail system only.

Call the number the controller is connected to.

When it answers and plays the Greeting, press the pound digit (“#”) to stop the Greeting.

Enter the password for the Mailbox (defined in the VoiceMail setup)

The controller will respond with “You have [number] (new) messages in Mailbox [number]”

At this point you are in the “MAIN” VoiceMenu menu. The VoiceMenu Prompt defined for “MAIN” will begin to play and the system will respond according to the structure of the VoiceMenu setup.

Local Access

Switch to INTERCOM by pressing the *ICM Access Code* or take a phone connected to the intercom (ICM) port off hook. Enter a password for the desired mailbox. It will respond with “You have [number] (new) messages in Mailbox [number]”. At this point you are in the “MAIN” VoiceMenu menu. The VoiceMenu Prompt defined for “MAIN” will begin to play and the system will respond according to the structure of the VoiceMenu setup.

WinEVM Access

From the *Utilities | VoiceMail* dialog box, each mailbox can be accessed. The dialog box displays the number of new and total messages stored in each mailbox and allows playback/review and deleting of messages via the mouse.

Schedule Access

VoiceMail functions can also be accessed and controlled via the schedule. This is useful for setting up advanced voice mail functions such as toll saver, outgoing message selection based on time of day, pager notification based on Caller ID, etc.

IF Conditions can be based on the number of New or Old Messages in a specific Mailbox. They can be treated like variables with the full complement of Compare Options.

THEN Actions include: Say Number of Messages, Play First Message, Next Message (skip), Delete Message, Replay Message, Play Caller ID, Stop Message, Play All Messages, Play New Messages, Backup 5 Seconds, Forward (advance) 5 Seconds, Select Greeting, Force VoiceMail, Announce Only On/Off, Answer on Ring (set ring count), Incoming Call Monitor On/Off, Load User_VAR with # of NEW Messages, Load User_VAR with # of OLD Messages, and VoiceMail Output selection (Speaker, Line Level Out, ICM or C.O. Line).

Define - VoiceMail-Remote Access

** Telephone/Voice Option **

This menu sets up the VoiceMail Remote access feature. ***Requires the Telephone/Voice option be installed.***

Access Mode

None – Select to disable any Remote Access

Remote Access System – Select to enable Command Mode Remote Access *only*. Command Mode allows the TouchTone to X10 commands (i.e., *11 to turn A-1 ON).

Enable Voice Menu System – Select to enable the VoiceMail & VoiceMenu system.

Access Parameters

Answer on Ring – Enter the number of rings the controller will wait before answering incoming calls (default = 8).

Remote Timeout - Enter the number of seconds the controller will wait for a valid Remote Access code otherwise hang up (default = 30).

VoiceMail

Announce only - Check to play the Main1 Mailbox Greeting then hang-up without recording Incoming Messages.

Maximum Record Time – Enter the maximum number of seconds the controller will record each Incoming Message.

Incoming Call Monitor – Check to monitor incoming calls. *Note: Both the Greeting and Incoming Messages will be directed to the selected output.*

Mailboxes

Enable – Check to enable the mailbox.

Password – Enter a Password to access the associated Mailbox.

Greeting – Outgoing Message. Double Click to edit.

Macro Enable – Select to run a Macro after a new message is left in the associated Mailbox.

Macro to run after message – After a message is left in this mailbox; this macro will be executed if the Macro Enable box is checked. Typical uses for this macro would be for notifying a pager of a new message left in the mailbox.

VoiceMenu

VoiceMenu sub-menus are accessible by pressing the Tab button across the top of the screen.

VoiceMenu Prompt

Each sub-menu will play a series of Voice Prompts when accessed. Selecting the “EDIT” button changes the prompts.

Touch-Tone Action

Action that will occur when the touch-tone digit is pressed. The Action can be one of the following:

Do Nothing – Do Nothing when pressed.

Do Macro – Trigger a macro.

Goto Menu – Go to another VoiceMenu sub-menu.

VoiceMail – Execute a VoiceMail function.

Goto Command Mode - Exit the VoiceMenu and switch to Command Mode.

HangUp – Disconnect.

VoiceMail Examples

TOLL SAVER

When the Toll Saver function is used with standard answering machines, calls are answered after 1 or 2 rings if there are new messages. If no new messages are recorded it answers after 4 or more rings. When calling in remotely to check messages, if the phone rings more than 1 or 2 times, the user knows there are no new messages and can hang up without being charged for the call.

Through the schedule, the VoiceMail “Answer On Ring Number” can be controlled based on Caller ID, Mailbox number, time of day, etc. to allow a more flexible “Toll Saver” function.

Example 6.5. EVENT: Toll Saver
If
 (VMAIL:MBX-1 # New Msg) >= 1
Then
 VM:Answer on Ring 2
Else
 VM:Answer on Ring 4
End

FORCE VOICEMAIL

The Force VoiceMail function lets you initiate any VoiceMail Box as if it answered an incoming call.

This facilitates many custom functions such as:

1) Automatically directing calls to specific Voice Mailboxes based on Caller ID.

2) Live transfer of calls to VoiceMail Boxes via touchtone sequences. (After answering or placing a call you can transfer the call to any VoiceMail Box).

Example 6.6. EVENT: Force VoiceMail (Caller ID)
If
 CallerID: 2125551212
Then
 VM:Force VoiceMail - Mailbox 2
End

Example 6.7. EVENT: Force VoiceMail (Touchtone)
If
 CO: Is OFF Hook
Then
|-If
| Telephone Seq:'2*' Received within 3 seconds
|Then
| VM:Force VoiceMail - Mailbox 2
|- Nest End
|-If
| Telephone Seq:'3*' Received within 3 seconds
|Then
 VM:Force VoiceMail - Mailbox 3
- Nest End

```

-If
| Telephone Seq:'4*' Received within 3 seconds
|Then
| VM:Force VoiceMail - Mailbox 4
- Nest End
End

```

MESSAGE WAITING BEEP

This event will play a beep sound through the speaker output every two minutes to notify you that there are new messages in Mailbox 1. The beep sound will stop after all new messages have been played back.

Example 6.8.

```

EVENT: MESSAGE WAITING BEEP
  If-Always
    (VMAIL:MBX-1 # New Msg) > 0
  Then
    Voice: BBBeep [Spkr]
    DELAY: 0:02:00
  End

```

CUSTOM OUTGOING MESSAGES

This event will select a custom Greeting (outgoing message) based on a matched Caller ID. If no match occurs, the default Greeting will be selected. This allows personalized greetings to be played to familiar callers (friends, family, associates, etc.).

```

Example 6.9. EVENT: CUSTOM GREETING
  If
    CallerID: ??????????
    " Look for any CallerID coming in "
  Then
    " Always change to default "
    " greeting after any CID, this "
    " will make sure proper greeting "
    " is selected. "
    VM:Change Mailbox 1 Greeting to Main Greeting
    " Now look for special numbers in "
    " order to change the greeting the "
    " caller will hear. If no numbers "
    " match, the default greeting will "
    " be used. "
    |-If
    | CallerID: 6195551212
    |Then
    | VM:Change Mailbox 1 Greeting to Dad
  End
  |-If
  | CallerID: 6194878787
  |Then
  | VM:Change Mailbox 1 Greeting to Jeff
  |- Nest End
End

```

Example VoiceMenu Setup

The Macros used in this example are listed below

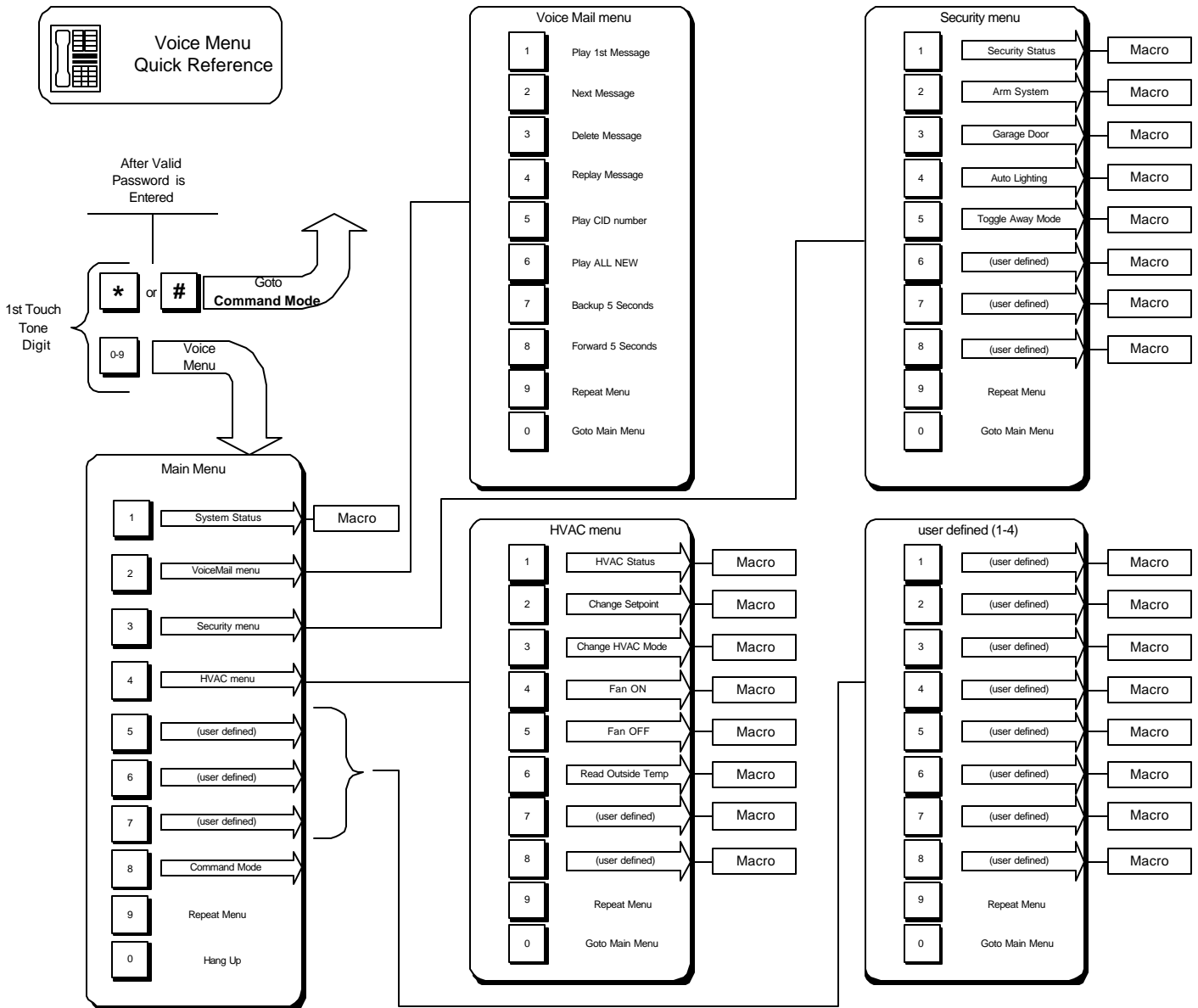

Figure 4 : Example VoiceMenu System

Main Menu Macros

Example 6.10. THEN Macro: System Status

```

MACRO BEGIN
" Main Menu System Status"
Voice:<day hh:mm am/pm> [CO]
|-If
|{(DI:Sec Armed) is ON
|Then
| | Voice: SECURITY SYSTEM IS ARMED [CO]
|Else

```

```

| Voice: SECURITY SYSTEM IS DISARMED [CO]
|- Nest End
|-If
|X10: (I-1 Home Mode) is ON
|Then
| Voice: HOME MODE IS ENABLED [CO]
|Else
| Voice: HOME MODE IS DISABLED [CO]
|- Nest End
|-If
|(F:Vacation Mode) is SET
|Then
| Voice: Vacation Mode [CO]
|Else
| Voice:Vac Mode Dis [CO]
|- Nest End
|-If
|(F:Alarm Violation) is SET
|Then
| Voice:ALARM HAS BEEN VIOLATED [CO]
|Else
| Voice:ALARM STATUS IS SECURE [CO]
|- Nest End
MACRO END

```

HVAC Menu Macros

Example 6.11. THEN Macro: HVAC Status

```

MACRO BEGIN
Voice: INSIDE TEMPERAT IS Thermo Temperature DEGREES [CO,ICM]
Voice: SET TO Thermo Setpoint DEGREES [CO,ICM]
MACRO END

```

Example 6.12. THEN Macro: Change Setpoint

```

MACRO BEGIN
Voice: SET TO Thermo Setpoint ENTER NEW TEMPERAT [Spkr,CO,ICM]
TouchTone to user_VAR SYNC
(V:Temp Setpoint) load with user_VAR
|-If
|(V:Temp Setpoint) < 80
|(V:Temp Setpoint) > 60
|Then
| (HVAC:Thermo) Change Setpoint to value in user_VAR
| Voice:BBBEEP [CO,ICM]
| DELAY 0:00:04
| Voice:NEW SET TEMPERAT IS Thermo Setpoint DEGREES [CO,ICM]
|Else
| Voice:INVALID TEMPERAT [CO,ICM]
|- Nest End
MACRO END

```

Example 6.13. THEN Macro: Change HVAC Mode

```

MACRO BEGIN
|-If
| " use variable HVAC Mode to keep track"

```

```

| “ Mode == 0: OFF Mode”
| “ Mode == 1: HEAT Mode”
| “ Mode == 2: COOL Mode”
| “ Mode == 3: AUTO Mode”
| “ ”
(V:HVAC Mode) INCREMENT
|-If
|(V:HVAC Mode) = 4
|Then
| (V:HVAC Mode) LOAD with 0
|- Nest End
| “ ”
|-If (V:HVAC Mode) = 1
|Then
| (HVAC:Thermo) HEAT Mode
| Voice:HEATING MODE [CO]
|- Nest End
|-If
|(V:HVAC Mode) = 2
|Then
| (HVAC:Thermo) COOL Mode
| Voice:COOLING MODE [CO]
|- Nest End
|-If
|(V:HVAC Mode) = 3
|Then
| (HVAC:Thermo) AUTO Mode
| Voice:AUTOMATI MODE [CO]
|- Nest End
|-If
|(V:HVAC Mode) = 4
|Then
| (HVAC:Thermo) OFF Mode
| Voice:OFF MODE [CO]
|- Nest End
MACRO END

```

Example 6.14. THEN Macro: Fan ON

```

MACRO BEGIN
(HVAC:Thermo) Fan ON
Voice:FAN ON [CO]
MACRO END

```

Example 6.15. THEN Macro: Fan OFF

```

MACRO BEGIN
(HVAC:Thermo) Fan OFF
Voice:FAN OFF [CO]
MACRO END

```

Example 6.16. THEN Macro: Read Outside Temp

```

MACRO BEGIN
“ example to be inserted”
MACRO END

```

Security Menu Macros

Example 6.17. THEN Macro: Security Status

```

MACRO BEGIN

```



```

|-If
|(DI:Alrm Violate) is ON
|Then
| Voice:ALARM STATUS IS VIOLATED [CO,ICM]
|Else
| Voice:ALARM STATUS IS SECURE [CO,ICM]
|- Nest End
MACRO END

```

Example 6.18. THEN Macro: Arm System

```

MACRO BEGIN
|-If
| " make sure it's off "
|(DI:Sec Armed) is OFF
|(DI:Sys Ready) is ON
|Then
|" Close relay for 1 second to arm"
| (RELAY:Alarm Toggle) ON
| DELAY 0:00:01
| (RELAY:Alarm Toggle) OFF
|- Nest End
DELAY 0:00:03
|-If
|CO: Is OFF Hook
|or ICM: Is OFF Hook
| -AND-
|(DI:Sec Armed) is ON
|Then
| Voice:SECURITY SYSTEM ARMED [CO,ICM]
|- Nest End
|-If
|CO: Is OFF Hook
|or ICM: Is OFF Hook
| -AND-
|(DI:Sec Armed) is OFF
|Then
| Voice:SECURITY SYSTEM NOT ARMED [CO,ICM]
|- Nest End
MACRO END

```

Example 6.19. THEN Macro: Garage Door

```

MACRO BEGIN
" Give status of Garage Door, give "
" option to close if it is open "
|-If
|(DI:GarageDoorSW) is ON
|Then
| " if Garage door open, say it "
| Voice:GARAGE DOOR IS OPEN [CO]
| " Give option to close "
| " Press 33# to close door "
| Voice:TO CLOSE PRESS 30 3 POUND [CO]
| " Get value, anything other than "
| " 33# will not affect the door "
| TouchTone to user_VAR SYNC
| (V:Counter 1) load with user_VAR
| |-If
| |(V:Counter 1) = 33

```

```

| |Then
| | Voice:CLOSE [CO]
| | (RELAY:Garage Door) ON
| | DELAY 0:00:01
| | (RELAY:Garage Door) OFF
| |- Nest End
|Else
| Voice:GARAGE DOOR IS CLOSED [CO]
|- Nest End
MACRO END

```

Example 6.20. THEN Macro: Auto Lighting

```

MACRO BEGIN
Voice:AUTOMATI LIGHTING IS [CO]
|-If
|(F:Auto Lighting) is SET
|Then
| Voice:ENABLED [CO]
|Else
| Voice:DISABLED [CO]
|- Nest End
Voice:TO SELECT AUTOMATI LIGHTING PRESS 1 POUND [CO]
Voice:TO D SELECT AUTOMATI LIGHTING PRESS 2 POUND [CO]
Voice:ELSE PRESS 3 POUND [CO]
TouchTone to user_VAR SYNC
(V:Counter 1) load with user_VAR
|-If
|(V:Counter 1) = 1
|Then
| (F:Auto Lighting) SET
| Voice:AUTOMATI LIGHTING ENABLED [CO]
|- Nest End
|-If
|(V:Counter 1) = 2
|Then
| (F:Auto Lighting) CLEAR
| Voice:AUTOMATI LIGHTING DISABLED [CO]
|- Nest End
MACRO END

```

Example 6.21. THEN Macro: Toggle Away Mode

```

MACRO BEGIN
|-If
|(FLAG:HomeMode) is SET
|Then
| " if set clear it, else set it "
| Flag: HomeMode CLEAR
|Else
| Flag: HomeMode SET
|- Nest End
MACRO END

```

Define - User Voice Responses

*** Telephone/Voice Option ***

The **User Voice Response** menu lets you name and record your own custom voice responses. Up to 128 user record-able responses are available. ***This requires the Telephone/Voice option to be installed.***

Recording Voice Response from a Phone

To record a voice response via a telephone connected to the ICM path or from a phone on the C.O. LINE:

1. Click on **DEFINE** then click on **USER VOICE RESPONSE**.
2. Click on a blank line in the VOICE RESPONSE list and type the name of the response you wish to record (up to 16 characters).
3. Select INTERCOM or C.O. LINE (the source you wish to record from) in the **RECORD SOURCE** box.
4. With the telephone receiver off hook, click on **RECORD**.
5. At the beep, speak the desired prompt into the phone, then click **STOP**.
6. To review, select INTERCOM, C.O. LINE, LINE LEVEL or SPEAKER in the **PLAYBACK TEST** box then click **PLAY**.

TIP! You can record off of the phone line (C.O. Line) during a call to capture voice responses from friends, associates, etc. These can then be added to events for custom applications. For example, you can record each friend saying "It's [friend's name] calling, pick up the phone" then have their responses broadcast over speakers when Caller ID recognizes their numbers!

Recording Voice Response from Line Level Input

To record a voice response via the LINE LEVEL INPUT:

1. Click on **DEFINE** then click on **USER VOICE RESPONSE**.
2. Click on a blank line in the VOICE RESPONSE list and type the name of the response you wish to record (up to 16 characters).
3. Select LINE LEVEL INPUT in the **RECORD SOURCE** box.
4. Connect the LINE LEVEL INPUT of the Telephone/Voice Board to the line level output of the device you are recording from (sound card, tape player, mixer, preamplifier, etc.).
5. Begin playing the source voice response and click on **RECORD**.
6. When the source voice response has completed, click **STOP**.
7. To review, select INTERCOM, C.O. LINE, LINE LEVEL or SPEAKER in the **PLAYBACK TEST** box then click **PLAY**.

Voice Functions

The **VOICE OUTPUT** menu lets you create voice responses for use as prompts, acknowledgements, signals, messages, etc. There are six types of voice responses:

- **Presets** (Over 600 built-in words, phrases and sound effects),
- **User-Defined** (up to 128 user-recorded words, phrases and sound effects),
- **Analog** (analog input values),
- **Variable** (variable values),
- **HVAC** (SetPoint and temperature),
- **Special** (time, date, last caller ID, TimeLabel, etc.).

Voice responses can be used individually or combined into sentences and can be sent to any or all of four output zones:

SPEAKER - output (screw terminals) which could directly drive several speakers at normal listening volume.

LINE-LEVEL - output (RCA phono jack) that can be connected to an amplifier, receiver, etc. when greater amplification is required.

C.O. LINE - output (RJ-11 jack) which allows playing/recording voice responses via the outside telephone line.

INTERCOM -output (RJ-11 jack), which allows playing/recording voice responses via the built-in intercom line.

Voice responses can be sent synchronously or asynchronously to accommodate different applications.

When sent synchronously, a voice response will play completely before the next line of the event is executed.

When sent asynchronously, a voice response will play while the next line of the event is executed.

Note: Wave files can only play asynchronously.

Define - COM Ports

Serial ports COM2 and COM3 can be independently configured in two Modes, General Purpose or Modem, and selectable baud rates and data format. COM1 is reserved for communication to the PC, the parameters for COM1 cannot be changed and are pre-defined at 9600 bps, N81.

General Purpose Mode

In General Purpose mode, the COM port can use ASCII In or Out commands from a schedule. The baud rate and comm. parameters must match the serial device's parameters.

Modem Mode

If an external modem will be used to communicate to the controller, configure the COM port to Modem mode. It is recommended to set the baud rate to 9600 to match the primary (COM1) serial port rate.

Define – Security

*** Serial Port Option ***

Controllers with the additional COM2/COM3 serial ports can interface to a security panel subsystem.

Select Security System Type

1. CADDX NX8 OR NX8E.

At this time only the CADDX NX8/NX8E panels are supported.

Model NX8 requires a NX584 interface card for serial communication with the controller.

Model NX8E has a built-in serial interface and does not require a NX584.

NOTE: The NX-584 has four jumpers that can switch the functions of the serial port pins. Leave the NX-584 jumpers in their default positions.

Configure WinEVM Software:

- 1) Open the Security System Configuration screen under the Define menu.
- 2) In the "Security system type" box, select "CADDX NetworX".
- 3) In the "Serial Port Used" box, select the controller's serial port number the security system is connected to.
- 4) For each zone, you can enter a descriptive name. This name will be used in your schedule.
- 5) Click OK. WinEVM will configure the controller's serial port for use with the CADDX Security Panel.

At this point, you can use the IF and THEN statements in your schedule. Use the MegaController to monitor security panel activity to verify communication with the security system properly.

Refer to the Application note - Interfacing to the CADDX NX8/6/4 Security System.

UTILITIES Menu Functions

The WinEVM Main Menu's Utilities Menu is a collection of utilities that are used to interactively send X10 commands, stop and start schedule, read/set the time and date, do an X10 signal test, read Message Log and calculate the free memory available on your PC.

Utilities - Mega Controller

The **Mega Controller** selection will open the Mega Controller window. When selected, Event Manager will take a short time to upload the current status of the Devices.

The MegaController is a powerful On-Line interactive controller. It allows you to:

- Monitor the status of all 256 X10 devices
- Control all 256 X10 devices
- Send any X10 command
- Send the Status Request command (used with 2-way X10 devices)
- Send Preset Dim and Micro-Dim/Bright commands (used with PCS lighting modules and RCS thermostats)
- Display the last 100 commands that transmitted or received (HISTORY).
- Log the controller Activity to a file
- Read status, set or clear Flags
- Read and set Variable values
- Read Timers
- Read status of I/O devices (Digital Inputs, Analog Inputs, Relay Outputs)
- Set or Clear Relays
- Control HVAC (thermostats)
- Dial telephone numbers
- Send ASCII text
- Play .wav files

<u>Menu Choices</u>	<u>Description</u>
---------------------	--------------------

HouseCode	HouseCode used when an X10 command is sent. The current HouseCode will be displayed in HouseCode window left of the X10 matrix. To change the HouseCode, click with the left mouse button on the HouseCode arrow, or click the HouseCode on the X10 matrix (leftmost column).
StatReq	This button will send the 'Status Request' command. This command <u>has</u> to follow a Unit Code command. A 2way X10 device will respond to this command with the 'Status = ON' or 'Status = OFF' command.
History	This button will clear the Activity Log and print the last 200 commands transmitted or received.
Clear	This button will clear the Activity Log screen.
Log to File	Selecting this button will cause the contents of the Activity Log to be saved into a file.

- Lock Scrolling** Selecting this button will prevent the Activity Log from scrolling when the MegaController receives information from the controller.
- Activity Log** Activity that the controller sends or receives. A date and time stamp is applied to all activity. When the controller receives an X10 command, such as a command sent from a controller other than from itself (like a mini-controller), the 'Rec' keyword will be placed after the time stamp. This will let you know if the X10 command was sent by it or by another controller. The Activity Log has a maximum capacity of 200 lines.
- Colors...** This button will open another box that gives you the choice of colors for the ON/OFF/IDLE states in the X10 Matrix.

X10 Matrix

The X10 Matrix (grid) allows you to toggle the X10 device or set the device to a particular state using the Mouse. By clicking certain areas of the matrix, you can change the state of X10 devices.

To	Do this
Toggle an X10 Device...	Click on the device in the matrix with the left mouse button.
Set a device to a specific state ON/OFF	Click on the device with the right mouse button, a sub-menu will appear, select the state with the right mouse button.
Set the DIM/BRI level...	Click on the device with the right mouse button, a sub-menu will appear, select the Set Level choice, then select the level with right mouse button.
Send a PRESET level...	Click on the device with the right mouse button, a sub-menu will appear, select the PreSet Level choice, then select the level with right mouse button. NOTE: This command applies to PCS lighting modules and RCS bi-directional thermostats only.

Wave File and WinExec Support

Support for playing .wav files and executing other Windows programs is provided through the MegaController. The MegaController *must* be running for Wavefiles to play. To include a wave file in a schedule or execute another program, see the [ASCII Output](#) command.

Utilities - Start Schedule

The **Start Schedule** selection will start the execution of the schedule.

Utilities - Halt Schedule

The **Halt Schedule** selection will stop the execution of the schedule.

Utilities - Clear Schedule

The **Clear Schedule** selection will clear the schedule in the controller.

Utilities - TimeDate Set

The **TimeDate** selection will open the time and date read/set window.

<u>Menu Choices</u>	<u>Description</u>
Read Time	This button will read the controller's time and display it on the screen.
Set Time	Pressing this button will set the time with the time specified in the dialog box. Note that this will also set the Latitude, Longitude and Time Zone information, information that is needed for proper SunRise/SunSet calculations.
Done	This button will exit out of the Read/Set Time box. You must first press 'Set Time' to save any changes before pressing 'Done.'
Set Time	Pressing this button will set the time in the controller with the time specified in the dialog box. Note that this will also set the Latitude, Longitude and Time Zone information, information that is needed for proper SunRise/SunSet calculations.
Latitude	Displays and Sets the Latitude for your location (refer to Location chart in the Appendix).
Longitude	Displays and Sets the Longitude for your location (refer to Location chart in the Appendix).
Time Zone	This button will exit out of the Read/Set Time box. You must first press 'Set Time' to save any changes before pressing 'Done.'
Daylight Savings	Select this if Daylights Savings is observed in your area.
Refresh Interval	The period of time between Refresh cycles. This feature works with X10 Devices only. A Refresh operation will re-transmit the ON/OFF state of any X10 Device that has the Refresh Option enabled. This is useful if you have a device that turns itself ON or OFF mysteriously, or to override any local switching of lights.
Security Interval	The maximum amount of random minutes added or subtracted from the specified time when 'Security Mode' is selected. Every day at midnight, the controller will use this Security Interval to calculate a random number that is between 0 and the Security Interval. If an Event is using a time-based condition with the Security Mode option enabled, this random number is either added to or subtracted from (this is random also) the current time.

Example 7.1. Security Mode

if the Security Interval is set for 15 minutes, and you have an Event such as:

```

EVENT Security Lights
If
  Time = 8:00 PM SMTWTFS Security Mode
Then
  (X:Porch Light B-3) B-ON
End

```

The Porch Light could be turned on anytime between 7:45 PM and 8:15 PM.

Utilities - X10 Signal Test

The **X10 Signal Test** selection will open the X10 signal test window. This test is a tool that will send alternating X10 ON-OFF commands on the power line (you must have a TW523 or PSC05 X10 powerline coupler connected to the controller.) This is useful in finding areas of your home that may be receiving a weak X10 signal.

If you suspect that the X10 signal is not making it to parts of your home, set the code on an **X10 appliance module** to match the HouseCode/UnitCode used in this test. Start the signal test and test all areas of your home by plugging in the appliance module and listening for the module's ON/OFF click. Although this is not a scientific means for measuring signal strength, you can locate areas that are not receiving the X10 signals.

If you have areas that are not receiving the X10 signal (but need to), you may need to install a signal coupler or signal bridge or move your controller to a location in your home that will allow the signal to reach the dead areas.

<u>Menu Choices</u>	<u>Description</u>
HouseCode	Set the X10 HouseCode that will be used (A to P).
UnitCode	Set the X10 UnitCode that will be sent. (1-16)
Start	Pressing this button will start the signal test. It will send commands, in the following order, continuously until Stop/Cancel is selected. HouseCode - UnitCode HouseCode - ON HouseCode - UnitCode HouseCode - OFF ... repeating the sequence until the Stop Command is sent
Stop	Pressing this button will stop the signal test.
Cancel	Pressing this button will stop the signal test, and return to the Event Editor.

Utilities - System Info

The **System Info** selection takes a snapshot of the controller's status and displays it in a window. Some of the status information that is displayed is:

- Firmware Version
- Current Schedule
- Time
- SunRise/SunSet times
- Latitude, Longitude, Time Zone
- Percent of Schedule memory used

Utilities - Message Log

The **Message Log** selection opens the Message Log window that allows you to read any Message that has been logged.

<u>Menu Choices</u>	<u>Description</u>
Read Messages	Pressing this button will read any Message that has been stored.
Clear Messages	Pressing this button will clear the Message display and clear any Messages that have been stored.
Save To File	Pressing this button will allow you to save the Message display to a file, with the file extension of ".msg".

Utilities – Telephone Log

The **Telephone Log** selection opens the Telephone Log window. You can view the Log and set/change the telephone log options from this window.

Utilities – Voice Mail

The **Voice Mail** selection will open the Voice Mail Playback window. This lets you see how many messages are in each of the 8 mailboxes. You can also select the playback output method. Answering machine like controls provide playback control.

~~Utilities – Network Info~~

The **Network Info** selection displays a listing of devices that have been detected on both the AUX bus network and the RS-485 network. Information includes firmware version, RS-485 address and device name.

Utilities - Self Test

The Self Test selection opens the self test window. You can **Run** the Built In Self Test (BIST) on the controller from this window and it will test the serial port, internal memory, the clock-calendar chip and the X10 interface. Results of each test are displayed in the window.

If the X10 test fails, check the cable between the controller and the TW523 or PSC05 Powerline Interface, make sure it is firmly connected. If any other test fails, contact Technical Support.

Note: This test will clear any Schedule and Device states in the controller, so you will have to download your Schedule after using it.

Utilities - Modem

The **Modem** selection will open the “Dial PC Modem” control and setup window.

With the Remote Execution capability and Event Manager you can access your controller over the phone line using modems. This section describes the connections required, the setup of the modems and how to initiate a remote session.

For the Remote Execution feature to work, the controller must be directly connected to a 9600 baud (or better) Hayes compatible modem through a NULL modem adapter. Your PC must have an internal 9600-baud (or better) Hayes compatible modem or be connected to an external modem through a serial port.

Modem Setup

Before using, it is necessary to configure the modem parameters for your PC, for the remote modem and for the controller that will be connected to the remote modem.

To configure the remote modem (connected to the controller):

1. Connect the controller’s serial port to your modem using a null modem cable or adapter.
(A null modem cable or adapter reverses the ‘xmit’ (pin 2) and ‘receive’ (pin 3) lines to allow communication between devices with similar serial port pinouts such as a modem).
2. Remove power from the controller (unplug power transformer from wall).
3. Apply power to your modem and make sure it is On.
4. With your modem On, plug in the controllers power transformer.

- As the controller initializes, it sends the following MODEM SETUP STRING to your modem: AT S0=10 Q0 V1 X4 &W0 &Y0.

This assures that when power is restored after a power outage, your modem will be ready for remote operation. If a backup battery is going to be used, the controller will not experience a power outage and will not issue the modem setup string when power is restored. In this case, add an event to your schedule to send the setup string when power is restored.

- To change the MODEM SETUP STRING, select MODEM SETUP and edit the MODEM SETUP STRING as needed, then press [OK] to save the changes, or [CANCEL] to escape without saving anything.

<u>Menu Choices</u>	<u>Description</u>
---------------------	--------------------

Modem Port	Select the serial port to which the PC's modem is connected. It can be different from the port into which you plugged the controller.
Speaker	This section gives you control of your modem's speaker.
Volume	You can set your speaker's volume to low, medium or high.
Num Retries	Enter the number of times you want Event Manager to redial the phone number after an unsuccessful attempt (i.e., busyline).
Retry Interval	Enter the number of seconds Event Manager will wait before retrying the call.
Comma Pause	Set the duration of the pause (in seconds) that each comma represents. When Event Manager encounters a comma while dialing a number, it will pause the specified time before continuing.
Wait between Calls	This is the maximum length of time Event Manager will wait for the remote modem to answer. After this time limit has passed, Event Manger will 'time out' and hang up. Enter the number of seconds to wait for the call to time-out (i.e., no answer).
[]Pulse Dialing	If you are using a pulse-dial (rotary) phone line, select this box.
Answer on Ring	The number of rings to wait before instructing the modem to answer. If you select 0 for this number, the remote modem will never answer. Note, if the controller is not connected either remotely or locally, you will not be able to change this value.

Quick Dial Setup

The entries in the Quick Dial Setup box appear in the Quick Dial section of the Dial Modem box. The Quick Dial buttons act like the memory buttons on an automatic-dialing phone. Each Quick Dial button stores a name and number.

Connecting to a remote Controller

Selecting the Utilities Modem option from the main menu will put you into the Dial Modem box. Fill in the Dial Modem box. The following is a description of each field:

To	This is the phone number that the remote controller is at. You can automatically fill in the Name and Phone text-entry boxes using the Quick Dial buttons. You can also manually enter the information from the keyboard.
Quick Dial	The Quick Dial buttons work like the memory buttons on an automatic dialing phone. When you click on one, Event Manager automatically fills in the Name and Phone fields. Click on the Quick Dial Setup button to edit the Quick Dial section.

Callback Options

When connecting to a remote controller, you may be calling from a location that has an expensive phone connect fee, such as on a vacation. With the Callback option, once a connection is made with the remote controller, Event Manager will send the remote controller the Callback number. The remote controller will hang-up the line and call that number back.

<u>Menu Choices</u>	<u>Description</u>
---------------------	--------------------

Callback Enabled	If selected, Event Manager will send the Callback number to the remote controller once a connection is made. If not selected, the remote controller will answer and assume a normal connection.
Pulse Dial on Callback	If the remote controller uses a pulse-dial (rotary) phone line, select this checkbox. It will instruct the remote controller to dial the phone number using pulse-dial (rotary) method.
Number	This is the number that Event Manager will send to the remote controller to call back. It is the phone number that the modem in your PC is connected to.

Choosing the Start Command

Selecting the Start button will trigger Event Manager to start the calling procedure. The Dialing Status dialog box will appear and give you status of the call. You may abort the call at any time by selecting the Abort button or by pressing the [ESC] key on your keyboard.

The following sequence of events will take place after pressing the Start button:

<u>Event Manager</u>	<u>remote Controller</u>
Dial number in 'To' section	waiting for call
	answer on 3rd ring
<i>(if Callback is enabled)</i>	
<i>send Callback number</i>	<i>hang up remote controller line</i>
<i>hang up line, wait for Callback</i>	<i>wait 10 seconds</i>
	<i>dial Callback number</i>
<i>answer on 1st ring</i>	
set REX flag	

After a connection to the remote controller is made, the REX flag (Remote EXecution) is set and will be shown on the status line (bottom line) of Event Manager. If the connection is ever lost or broken, the REX flag will be cleared and disappear from the status line.

Controlling a remote Controller

When you have established a connection, it can be controlled in the same manner as if it was still connected to your computer. You can create and download Schedules, access the MegaController, or do anything you would in a normal session.

Ending the modem session

When you are ready to hang-up the line, you can do one of two things:

1. From the Utilities | Modem box, select the Hang-up button and Event Manager will hang up the phone line from the modem.
2. Exiting out of Event Manager will hang up the phone line.

Utilities - Fonts

The **Fonts** selection brings up the Windows font selection window to allow you to select a screen font.

Utilities - Options

The **Options** window allows the user to select the Serial Port of the PC that is connected to the controller, select the IR Remote type, and set X10 options.

<u>Menu Choices</u>	<u>Description</u>
Serial Port	Select the serial port, 1 – 4 , that the PC will use to communicate to the controller Note: This is not the serial port used for <i>remote communications</i> , but the PC serial port that the controller is directly connected to. (A PC must be connected to run this program!)
IR Remote Type	Select 'IR-Xpander' if you have an IR-XP2 InfraRed Xpander connected to the AUX port. If a different IR Remote type is used, select it in the menu.
X10 Options	X10 Phase: Select Single Phase or 3 Phase . Select the setting that meets the requirements of your AC power service. Most households use Single Phase AC service. Commercial applications may require 3 Phase to be selected to enable transmission of the X10 signal on all phases. In environments with noisy power lines, the X10 signal that the Power Line Interface sees when it is sending can sometimes be altered enough that it thinks it did not send correctly, thereby causing it to re-send. By disabling the 3-Phase option, the controller will only send X10 transmissions at the zero crossing of the electrical phase it is connected to. Note that 3-Phase transmission is only needed in a 3-Phase environment; most households do not use 3-Phase wiring. Retrys: Select 1 to 5. The controller can detect X10 collisions when it is transmitting X10 signals by comparing what it is receiving from the Power Line Interface to what it sent. When a mis-match occurs, most likely it was a collision with another X10 transmitter or noise. It will attempt to retry the X10 command the number of tries selected, from 0, for no Retries, to 5.

Other WinEVM Main Menus

Window Menu

The WinEVM Main Menu Bar drop down **Window** menu allows standard window control.

- Cascade
- Tile
- Arrange Icons
- Close All

This menu also shows the Schedule name/s of the open schedule/s.

Help Menu

The WinEVM Main Menu Bar drop down **Help** menu provides a Help feature including:

- Contents
- Search for Help On
- How to Use Help
- **About...**

Note: Clicking on 'About' will display the version number for the WinEVM program installed on the system.

Event Programming - Event Basics

“Junior, **IF** you eat your vegetables, **THEN** you can watch TV, **ELSE** you’re going to bed!”

This section gives you an overview of what an Event is and how it is used in a schedule. An understanding of the Event concept is very important to make the most of your controller. Be sure that you understand this concept before you create your own schedule.

Basic Event Structure

An Event consists of an “IF” section, followed by a “THEN” section. If the “IF” section is **true**, the “THEN” section is executed. If the “IF” section is **not true**, the “THEN” section is skipped. There are two types of Events, the IF-THEN and the IF-THEN-ELSE.

IF-THEN Events

The simplest form of an Event is an IF-THEN:

```
if
  condition is true
then
  do action
end
```

If the condition is true, then the action is executed. This simple form of an IF statement gives you the choice of executing an action(s) or skipping it. IF’s are easy to understand because we use them constantly in our daily conversations.

If the opening statement was put into an IF-THEN statement, then it would look like this (see... even this sentence is an IF-THEN statement):

```
if
  eat your vegetables
then
  watch TV
end
```

IF-THEN-ELSE Events

Event Manger also lets you choose between two actions with the IF-THEN-ELSE structure.

```
if
  condition is true
then
  do action1
else
  do action2
```

In this example, if the condition is true, the first action is executed, if the condition is false, the action following the else statement is executed.

If the opening statement was put into an IF-THEN-ELSE statement, it might look something like this:

```
if
  eat your vegetables
then
  watch TV
else
  go to bed
end
```

IF Junior eats his vegetables, he can watch TV, IF he does not, he will have to go to bed.

~~Multiple Condition Events~~

More than one condition can be included in the IF conditions of an Event. They can be “AND” or “OR” conditions. This is referred to as the Logical Type (AND/OR) of the condition.

AND Conditions

If ‘AND’ is chosen, **all of the conditions** must be met before any action will be taken.

```
EVENT
If
    eat vegetables
    and dishes washed
Then
    watch TV
End
```

In this example, Junior must eat his vegetables **and** wash the dishes then he gets to watch TV, only doing one will not work. This is what the AND does: ***All of the conditions must be true in order to make the actions happen.***

OR Conditions

If ‘OR’ is chosen, **only one condition** has to be met before any action will be taken.

Suppose Junior’s mother decides not to be so tough, changing the orders to, “Eat you vegetables **or** wash the dishes and you can watch TV”.

```
EVENT
If
    eat vegetables
    or dishes washed
Then
    watch TV
End
```

Now junior has a choice, either eat his vegetables or wash the dishes, and he will be able to watch TV. This is what the OR does: ***Only one of the conditions has to be true in order to make the actions happen.***

Any number of IF conditions can be combined to control any number of THEN actions. For example:

```
EVENT sample event
If
    condition 1 is true
    and condition 2 is true
    and condition 3 is true
    and condition 4 is true
Then
    do this action
End
```

In this example, **all the conditions** must be met before the ‘THEN’ action will be executed.

Compound AND/OR Conditions

Event Manager can use compound AND/OR logic, combining AND and OR conditions in the same Event.

Example 8.1. Compound If/And/Or

```
EVENT OR/AND Sample Event
If
  (X:Alarm Active L 1) is ON
  and Time = 6:00 PM SMTWTFS
-OR-
  (X:Alarm Active L 1) is OFF
  and Time = 8:00 PM SMTWTFS
Then
  (X: Front Door B 1) ON
  (X: Garage Light B 2) ON
End
```

In this example, we want the outside lighting to turn on at a different time based on whether or not the security system is set. If the security system is ON and it's 6 PM, -OR-, the security system is OFF and it's 8 PM, then turn on the Front Door and Garage lights.

Multiple Action Events

More than one action may be executed in the 'THEN' section of the event.

For example:

```
EVENT sample event
If
  condition1 is true
  or condition2 is true
Then
  do action1
  do action2
Else
  do action3
  do action4
  do action5
  do action6
End
```

In this example, if **condition1** is true or **condition2** is true, then do action1 and action2, if neither condition is true, then do action 3, 4, 5 and 6.

Example 8.2. If/Then.

```
EVENT sample event
If
  Time = 6:00 PM .MTWTF.
Then
  (X: Frontporch Light B 3) ON
End
```

In this example, when the time is equal to 6 PM on any weekday but not weekends, the Frontporch Light turns on.

Example 4.3. If/And/Then.

```
EVENT sample event
If
  (F: Alarm Activated) is SET
  and Time = 6:00 PM .MTWTF.
Then
```

(X: Frontporch Light B 3) ON
End

In this example, if the flag 'Alarm Activated' is set **and** the time is equal to 6 PM on any weekday but not weekends, turn on the Frontporch Light.

Fast Events

Fast Events are special events and are used where time critical response is required, such as Events triggered by X10 ON/OFF commands, on-board Digital Inputs going ON/OFF or received INFRARED commands (requires compatible Infrared controller). These events are executed immediately when triggered, regardless of schedule size. A Fast Event is selected when you create an event and can be placed anywhere in the schedule.

Nesting

Nesting is a way to add complex decision making into your Events. **The maximum number of Nested Events is 3.**

Summary of 'IF' conditions

Time equal to hh:mm days	hh = hour , mm = min, days = SMTWTFS
Time is less than hh:mm days	hh = hour , mm = min, days = SMTWTFS
Time is greater than hh:mm days	hh = hour , mm = min, days = SMTWTFS
Time Label	Label given to a certain time
Date	(equal, before, after)
Equal to SunRise /SunSet days	days = SMTWTFS
Before SunRise/SunSet days	days = SMTWTFS
After SunRise/SunSet days	days = SMTWTFS
X10 Device	State = ON/OFF/IDLE Module A1 - P16
X10 Sequence	Up to 6 sequential X10 commands within a specified time window
Timer = Running, Stopped, Expired	32 timers (1 second resolution)
Flag = Set/Clear/Idle	256 flags
Variable "=", ">", "<", etc (0-255)	256 variables
IF Macro	A series of 'IF' conditions
ASCII Input	Up to 32 characters
System Variables	Power Restore, X10 loss, First Schedule Pass, Power loss
Digital Inputs	ON/OFF/Toggles/GOES On/GOES Off states of Digital Inputs
Analog Inputs	Value of Analog Input (0-255)
Relay Outputs	On/Off
Telephone Sequence	Any combination of Off-Hook/On-Hook/Touchstones within a specified time window
Telephone Line Status	On-Hook/Off-Hook/On-Hold/Off-Hold/CallerID/Ring/Remote Access
IR Sequence	Up to 10 sequential IR commands within a specified time window
IR Power Sensor	4 Power Sensors
VoiceMail "=", ">", "<", etc (0-255)	Compare number of New/Old Messages in any mailbox

Note: *Any combination of 'IF' conditions may be combined in an Event.*

Summary of 'THEN' actions:

X10 Device = ON/OFF/DIM/BRI	Module A1 - P16
All Lights On	HouseCode A-P
All Lights Off	HouseCode A-P
All Units Off	HouseCode A-P
Timer	Load/Clear/Start
Flag	Set/Clear
Variable	Load/Clear/Inc/Dec
Message Log	8K of message space
Then Macros	Series of 'THEN' actions
ASCII Output	Up to 32 characters
IR Commands	IR Commands sent by InfraRed-Xpander
Relay Outputs	On/Off control of Relays
Telephone	Off-Hook/On-Hook/TouchTones/On-Hold/Off-Hold/Hookflash/Pause
Voice	Play Voice Response, Record User Voice
Audio Path	Connect/Disconnect: CO Line/Intercom/Line-Level Input to CO Line/Intercom/Line-Level Output/Speaker
VoiceMail	All VoiceMail functions, load user_VAR with New/Old messages

Event Processing

After you download a Schedule, the controller will start with the first Event, check 'IF' conditions and do any actions, go on to the next event, do the appropriate actions, and so on until the end of the schedule is reached. The controller then starts over at the beginning of the Schedule evaluating the first Event.

Standard Events

Standard Events are based on an IF statement(s) and THEN actions and are processed in sequential order. **Utilities | System** Info will list the total time to complete one pass through a schedule.

When an event is evaluated, logic type is checked to see if the Event is AND or OR. The logic type is used to evaluate the conditions and decide whether to take the required action(s). For AND logic events, **all the conditions** must be true, for the OR logic events, **only 1 condition** has to be true.

Fast Events

Fast Events are Events triggered by X10 ON/OFF commands, on-board Digital Inputs going ON/OFF or received INFRARED commands (requires compatible Infrared controller). These events are executed immediately when triggered regardless of schedule size. A Fast Event can be placed anywhere in the schedule. Note that there can only be 1 Fast Event for a given trigger.

IF/THEN/ELSE Events.

Example 9.1.

```
EVENT sample event
If
  After SunSet SMTWTFS
  or Before SunRise SMTWTFS
Then
  SET (F:It's Dark)
Else
  CLEAR (F:It's Dark)
End
```

The flag "It's Dark" will be set if, the current time is after SunSet on any day, **or** if the current time is before SunRise on any day of the week, otherwise the flag "It's Dark" will be cleared.

Example 9.2. IF/THEN/ELSE.

```
EVENT sample event
If
  Time is After 5:00 PM .MTWTF.
  and Time is Before 8:00 PM .MTWTF.
Then
  (X:Security Light B 7) ON
Else
  (X:Security Light B 7) OFF
End
```

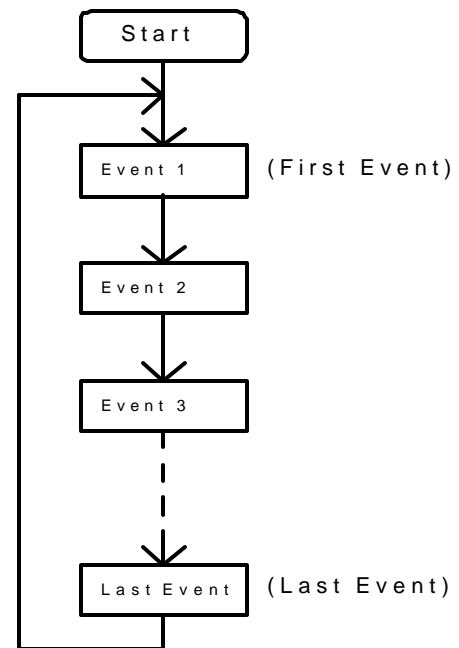

This event will turn on the X10 device that has the name “Security Light” if, the time is after 5 PM during weekdays **and** before 8 PM during weekdays. The event would turn the “Security Light” off when the time is not between 5 PM and 8 PM weekdays.

Important Note: If the Event is **not** ‘IF Always’, each time an Event is evaluated, the controller will not execute any action unless the conditions have changed since the last time the Event was evaluated. If the Event is ‘IF Always’, every time an Event is evaluated, The actions will execute if the IF conditions are met.

Using the previous example, if the current time was 4:59pm on Monday, the event would evaluate as not true (the first condition was not true, i.e., the current time was not after 5 PM), since during the previous evaluation cycle, the event evaluated as not being true, no changes occurred so no actions would take place. When the current time changes to 5 PM, both conditions are met (it is after 5 PM and before 8 PM), and the THEN actions are processed. On subsequent evaluation cycle no actions will be processed until the time is after 8 PM (because both IF’s are still true), whereas the event evaluates as not true, and the previous evaluation cycle evaluated as being true, the ELSE actions will be processed.

Example 9.3. IF/AND/THEN.

```
EVENT: sample event
If
  Time = 5:00 PM S....S
  and (X:HotTub B 5) is ON
Then
  (X:HotTub Blower B 6) ON
End
```

In this example, IF the X10 device ‘HotTub’ is ON, **and** the current time is 5 PM on Saturday or Sunday, THEN turn the X10 device ‘HotTub Blower’ ON.

Example 9.4. IF/OR/THEN.

```
EVENT: sample event
If
  Time equals 5:00 PM S....S
  or Time equals 6:00 PM .MTWTF.
Then
  (X:Porch Light B 3) ON
End
```

In this example, IF the current time is 5 PM on Sat or Sun, **or** the time is 6 PM on Mon-Fri., THEN turn on the X10 device ‘Porch Light’ ON.

IF Always Events

The Event in Example 8 is an ‘IF Always’ type of Event. When A-1 is turned ON, it will send the ‘B-1’ ‘B-ON’ X10 command followed by a 2 second delay, and keep repeating this command as long as A-1 is on. This type of Event will keep executing the actions as long as the if condition(s) stay true. When using “IF Always” it is recommended that you insert some delay to allow time for other X10 commands to be processed. In Example 9, when A-1 is turned on, ‘B-1’ ‘B-ON’ will be sent once, until A-1 is turned OFF and ON again. This type of Event must see the conditions change before the actions are executed.

Example 9.5. IF ALWAYS.

```
EVENT:
If Always
  (X:A 1) is ON
Then
  (X:B 1) ON
  Delay 0:00:02
End
```

Example 9.6. IF/THEN.

EVENT:
If
(X:A 1) is ON
Then
(X:B 1) ON
End

A Case Study: Otto Mashon uses X10 to control lights and radio.

Otto Mashon just completed his controller installation and is ready to start automating. He starts by automating his study. Otto has always wanted to push a single button on his X10 mini-controller to activate his Overhead Lamp and the Radio. (If you are not familiar with X10 power line communications, first refer to Appendix B "What is X10")

Otto will create a simple schedule using X10 to turn on Unit A7 (Overhead Lamp) and Unit A12 (FM Radio) whenever Unit B4 (button on his mini-controller) is pressed. He will follow the steps listed below:

- 1) Run WinEVM program
- 2) Define X10 devices
- 3) Create a Schedule
- 4) Download the Schedule
- 5) Test the Schedule

1) **Run WinEVM** - Otto starts the WinEVM program from his desktop or start menu.

2) **Define X10 Device** - Otto begins by making a list of the X10 devices. The list consists of the button on the mini-controller, the lamp and the radio. Once Otto's list is completed, he defines his X10 devices in WinEVM.

<u>NAME</u>	<u>LOCATION</u>	<u>DESCRIPTION</u>	<u>HOUSE/UNIT Address</u>
Study Lamp	Study	Overhead Lamp	A-4
Radio	Study	FM Radio	A-12
Switch1	Study	Mini-Controller	B-4

Select Define | X10 Device

Otto fills out the X10 Device List with the information for each X10 device that he wants to control and for each type of X10 controller that will be used (the mini-controller in this example).

When Otto is satisfied with the names and selections for the three devices that he will be using, he leaves the X10 Device List menu by pressing the [OK] button.

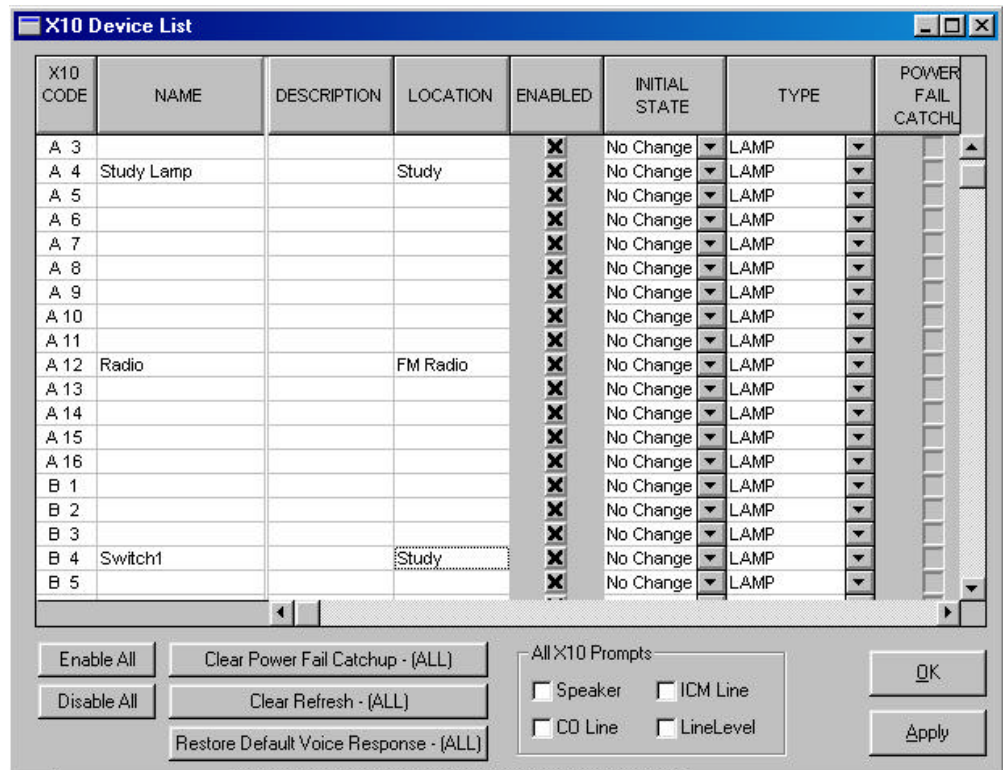

3) Create a Schedule

Now that Otto has the mini-controller, lamp and radio defined in the Device DataBase he wonders, *“How do I want these X10 devices to work together”*. He decides that when he enters his study, he wants to press a button on his mini-controller, and have both the Study Lamp and Radio to turn on. Likewise, when he leaves, he wants to turn the Study Lamp and Radio off with one button.

Otto starts thinking to himself,

“Now how will this work? If the switch on the mini-controller is ON, then turn ON the Study Lamp and the Radio. Lets see,”

```
if
    the mini-controller switch is ON
then
    turn the Study Lamp ON
    turn the Radio ON
end
```

Since he hasn't created a Schedule yet, his Editor Workspace is empty.

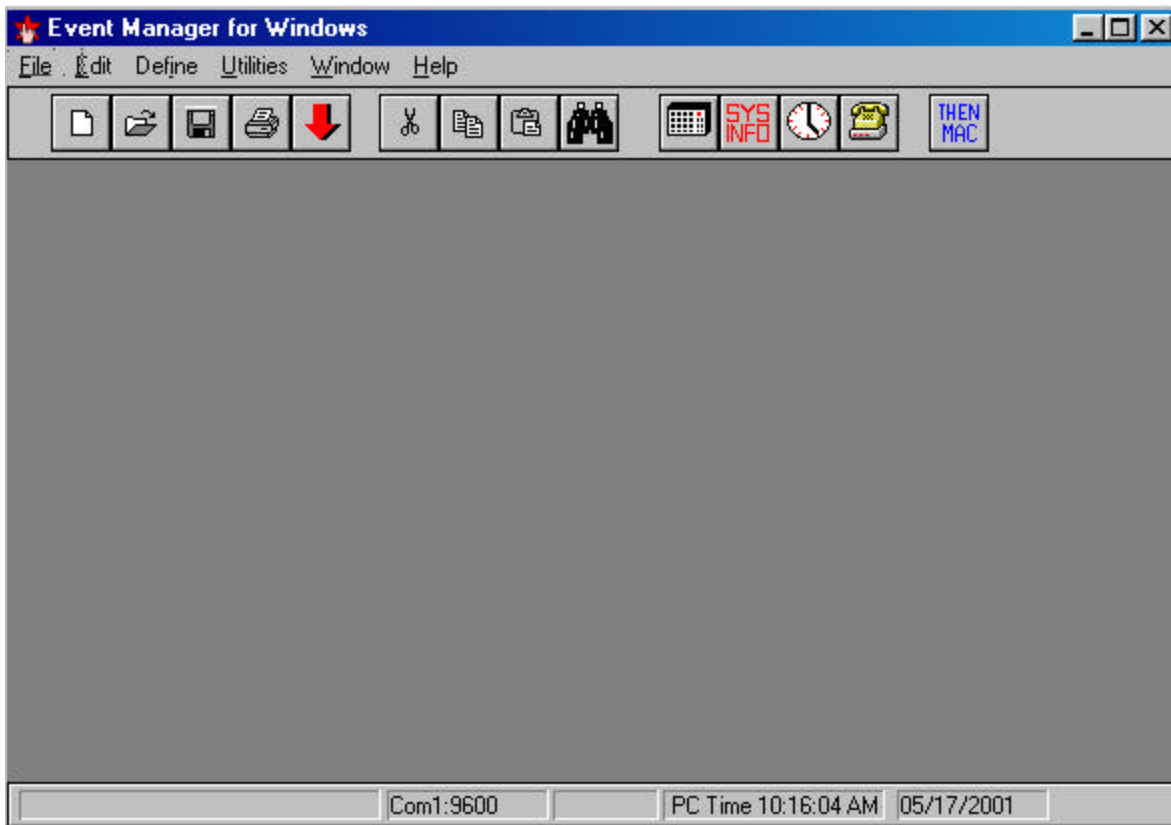

Otto creates a schedule by selecting File | New Schedule, an untitled and empty schedule is created.

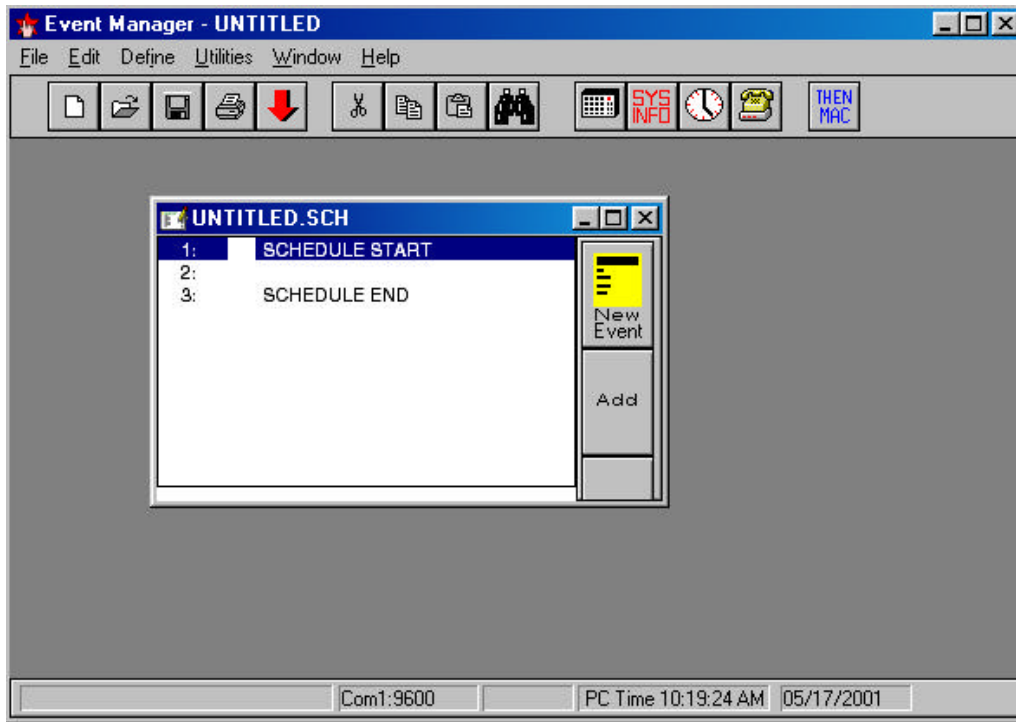

Otto creates his first Event by pressing the [New Event] button in the right side ToolBox. He fills out the Event Definition dialog box with the name and description of the Event. In this example the name is "Study On", the Event type is "IF-THEN", the logic type is "AND" and the insert point location is "After this Event"

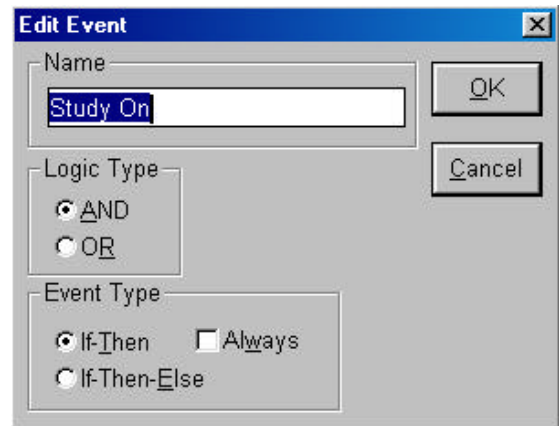

When satisfied with his selections, he presses the [OK] button to accept the new Event. The new Event he named "Study On" shows up in the Editor Workspace.

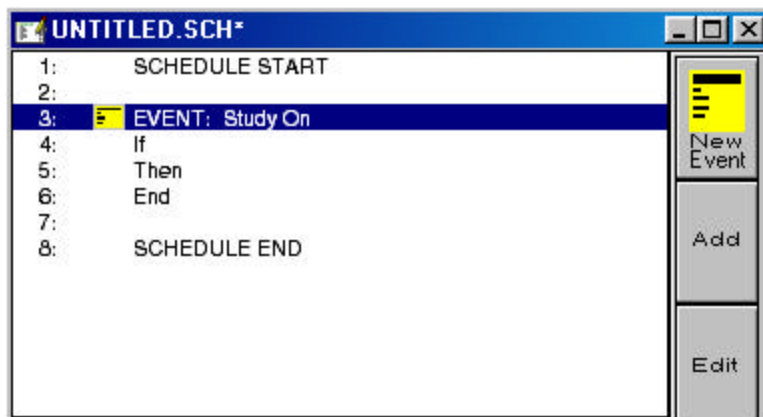

Looking at the schedule, Otto wondered how he could make the lamp and radio turn on when he presses the mini-controller button. *“Well, the first thing I have to do is make the button press on my mini-controller be the IF statement”*. He does this by:

- 1) Highlighting the 'IF' statement by selecting it with the mouse.
- 2) Press the [Add] button in the ToolBox. A popup menu appeared and he chose 'X10 Device State' since that is the type of device that he wants to use in this Event. After selecting 'X10 Device State', another popup window appeared. Otto chose 'Switch 1' from the list and the 'Module is ON' X10 condition. *“Now is this what I want”*, Otto thought, *“If Switch 1 is ON, yes that’s it”*.

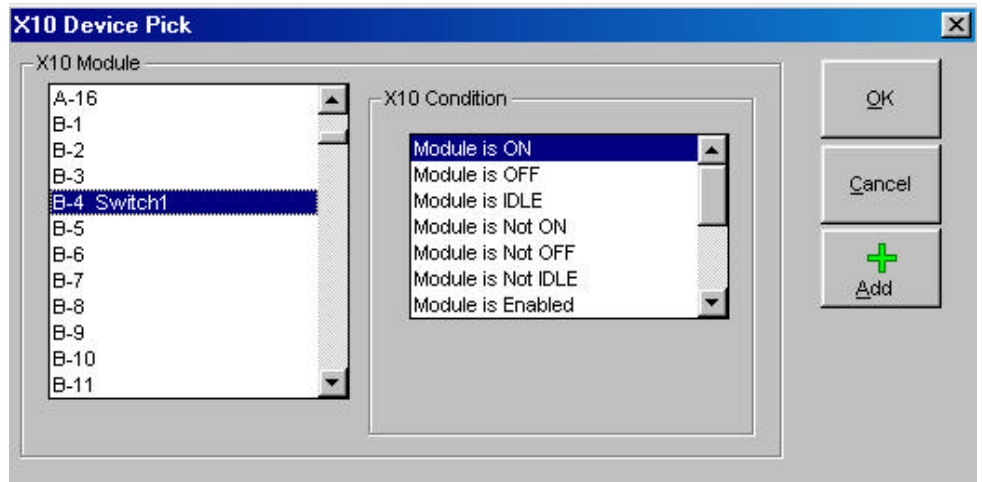

- 3) Press the [OK] button to accept this choice.

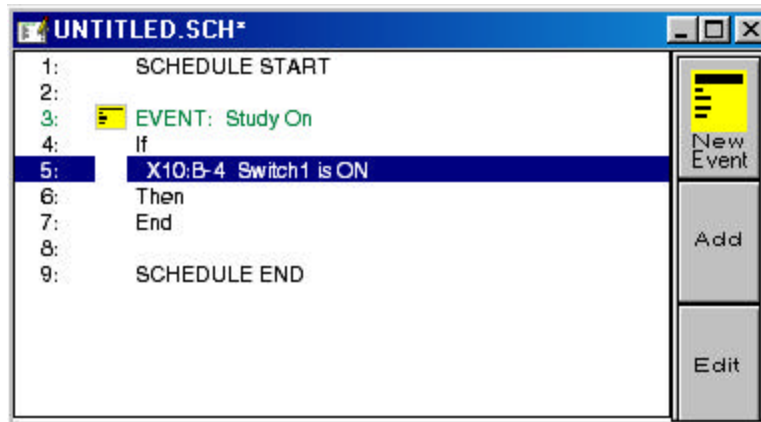

“Now that the 'IF' part of my Event is correct, I have to add the Study Lamp and Radio in this somehow”. Otto did this by adding an Action statement the same way he did the IF condition statement, by moving the highlight bar onto the 'THEN' statement in the Event, and pressing the [Add] button in the Toolbox.

He chose 'X10 Device' from the popup window and was put into the X10 Device Action dialog box.

Otto selects Study Lamp and selects ON from the X10 Command list. *“This is getting easy”*, Otto thought while pressing the [OK] button. The Event is updated with this selection. *“Now, all I have to do is add the Radio and I’ll be done”*, mused Otto.

Otto again selects the [Add] button in the Toolbox and the THEN Action popup window appears. Otto chose 'X10 Device' and the X10 Device dialog box appeared. He selects 'Radio' by highlighting it in the list box and selects the ON from the X10 Command list, then the [OK] button.

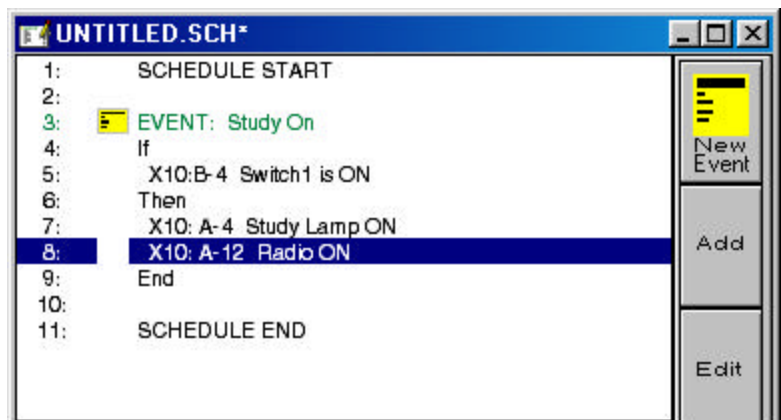

4) Download the Schedule

Otto decided that this Event was complete and he wanted to see if it would work. He saved the schedule first by selecting the **Schedule | Save As** menu, entering the name “sample” and pressing the [OK] button.

To download the schedule, Otto selected the **Schedule | DownLoad** menu

Otto chose **[x] Download Schedule** since he wanted to download his newly created schedule and the **[x] Download Device Database** option. With ‘Download Device Database’ selected, the controller will be downloaded with the Initial State values that were defined in the Device DataBase. The controller keeps track of all Devices and whether they are ON or OFF and by downloading the Initial States, you can pre-define an X10 Device to be ON or OFF. This is normally used for the first download only.

Pressing [Download], the schedule is downloaded and Otto was put back in the Workspace.

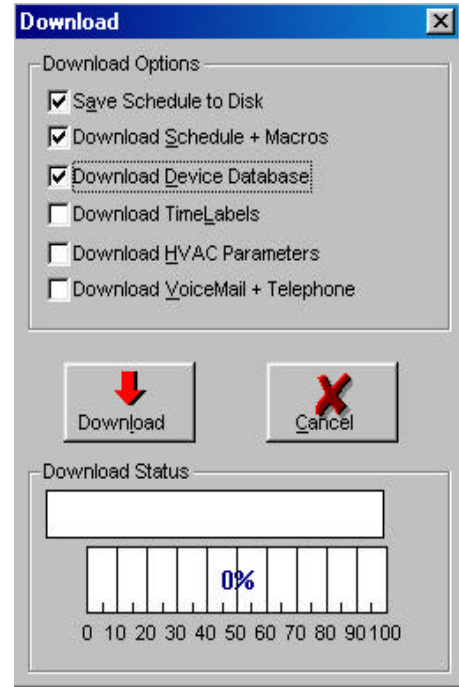

5) Test the Schedule

Otto, eager to try his new schedule, presses the “B4-ON” button on his mini-controller. This turned on the Study Lamp and Radio. Having created his first Event to turn them on, Otto is eager to create another to turn them off.

So Otto goes back to work to define a new Event, one that will turn the Study Lamp and Radio off when the mini-controller switch is turned off. Since he is using X10 devices that have been defined already, Otto does not have to define any new ones.

Otto decides that this Event will turn the Light and Radio OFF when the mini-controller button “B4-OFF” is pressed. He creates a new Event by pressing [New Event] in the ToolBox. He fills out the Event Definition dialog box and names this Event ‘Study Off’.

When satisfied with his selections, Otto presses the [OK] button to accept the new Event.

“I will make this Event work just like the first one, except replace the ON’s with OFF’s.” He did this by moving the highlight bar onto the ‘if’ statement in the Event and pressing the [Add] button in the ToolBox. A popup menu appears and he chooses ‘X10 Device’.

The ‘X10 Device’ dialog box appeared and he selects ‘Switch 1’ from the list of devices and the ‘Module is ON’ X10 condition. Otto presses the [OK] button to accept this choice.

Otto adds the Study Lamp and Radio, turning both of them OFF, to the ‘then’ part of the Event in same manner as he did in the first Event.

Otto decides that the new Event is complete and he wants to try it out. He saves the schedule first by selecting the **Schedule | Save** menu, since the schedule has already been named, it will be saved under the same name. Otto then selects the **Schedule | DownLoad** menu.

Otto chooses ‘Download Schedule’ from the DownLoad options but not the ‘Download Device Database’ option since he did not want to change the internal states in the controller, as they now reflect the actual states of these devices. Pressing [OK], the schedule is downloaded and Otto is back in the Workspace.

Otto presses the “5-ON” button on his mini-controller, and the Study Lamp and the Radio turns on. He then presses the “5-OFF” button, the Study Lamp and Radio turns off. “This is what it’s all about”, murmured Otto as he began defining new Events.

Otto is well on his way to an automated home. He has mastered the concept of defining devices in the DataBase and creating a basic IF-THEN Event.

Using the Event Editor to Create an Event

Creating events occurs in a schedule. Before you can create events you must first open or create a new schedule. To open a new schedule, select the File Menu and click on the 'New Schedule' option. An UNTITLED.SCH window will open. Expand this window to full screen.

EVM will have placed a skeleton schedule format in the default new schedule, like this:

- 1: SCHEDULE START
- 2:
- 3: SCHEDULE END

Event Editor ToolBox

Notice that to the right side of the schedule window is the Event Editor ToolBox. These are the functions most frequently used when creating and editing events in schedules.

New Event

You create new events in your schedule by first placing the cursor and highlighting the location in the schedule where you want the new event to occur. The new event will be placed either before or after the highlighted line depending on which option you select.

Selecting the [**New Event**] button in the ToolBox will bring up the New Event window with the following selections:

<u>Menu Item</u>	<u>Description</u>
Name	The name of the Event. This name will appear in the schedule
Event Type	The type of Event that you want to create. <ul style="list-style-type: none">▪ IF-THEN▪ IF-THEN-ELSE▪ FAST EVENT
Always	If the Always checkbox is selected, the action will always execute if the conditions are met. If not selected, the controller will not execute any action unless the conditions have changed since the last time the Event was evaluated.
Logic Type	The logic type of the Event, AND or OR.
Insert Point	This will place the new Event above or below the Event that is currently highlighted.

After selecting [OK], an empty Event will be inserted into your schedule.

Fast Events

Events triggered by X10 ON/OFF commands, Digital Inputs (the controllers built-in) going ON/OFF or Received Infrared command are Fast Events. These events are executed immediately when triggered regardless of schedule size.

Note that there can only be one Fast Event for a given trigger.

Adding If Conditions and Then Actions to Events

After creating the event shell, you add **IF Conditions** or **THEN Actions** to the Event by moving the highlight bar to where you want the statement to be inserted and selecting the **[Add]** button in the Event Editor ToolBox.

IF CONDITIONS

If you want to add an IF statement, move the highlight bar to the IF section of the Event, that is between the 'EVENT' and the 'Then' lines, and press the **[Add]** button in the ToolBox.

The 'IF Condition' popup menu will appear and by using your mouse or the arrow keys on the keyboard, move to the *type of IF Condition* you want and press the <Enter> key or click [OK] with your mouse.

THEN ACTIONS

To add a THEN statement, move the highlight bar to the THEN or ELSE section of the Event, then press the **[Add]** button in the ToolBox.

The 'THEN Action' popup menu will appear and by using your mouse or the arrow keys on the keyboard, move to the *type of THEN Action* you want and press the <Enter> key or click with your mouse.

Edit Event

To Edit an Event (IF Condition or THEN/ELSE Action), move the highlight bar to the item to be edited and select the Toolbox **[Edit]** button (or double-click the left mouse button on the line to be edited). The Edit Event window will appear with the name, event type and logic type fields filled in. When you are done with your changes, press the [OK] button to save. By pressing the <ESC> key or the [Cancel] button, any changes are discarded

Note: *when changing from an IF-THEN-ELSE type Event to an IF-THEN type Event, all of the actions after the ELSE statement must be deleted before it can be changed*

Delete Event

To Delete an *IF Condition* or *THEN/ELSE Action*, move the highlight bar to the item you want to delete and select the Toolbox **[Delete]** button.

Event Programming with IF Conditions

An Event uses IF Conditions to decide whether to do the THEN or ELSE actions. IF Conditions can be based on time, date, sunrise/sunset, state of an X10 device, received X10 sequence, received infrared, timers, variables, flags, digital inputs, analog inputs, relay outputs, ASCII input, telephone input (TouchTones, ring, Caller ID, on-hook, off-hook) and system variables (first schedule pass, X10 loss, ac power loss, power restored).

To add an IF Condition to an Event, move the highlight bar in the IF section of the Event and select the **[Add]** Toolbox button. A pop-up menu will appear allowing you to choose the type of IF condition. Select what type of IF Condition you want with the mouse. A window will open and allow you to fill in the information for the IF Condition that was chosen.

IF Condition Menu

The following IF condition selections are on the IF Condition pop-up menu when you select the **[Add]** button in the Edit Event ToolBox.

- **X10 Device State**
- **X10 Sequence**
- **Timer**
- **Flag**
- **Variable**
- **IF Macro**
- **Comment**
- **Time**
- **Time Label**
- **Date**
- **Sunrise/Sunset**
- **ASCII In**
- **OR**
- **AND**
- **System Variable**
- **Relay State**
- **Digital Input**
- **Analog Input**
- **IR**
- **HVAC**
- **Telephone**
- **VoiceMail**
- **LCD DigitPad**
- **Security**

IF - X10 Device State

Selecting X10 Device State from the menu will open the X10 Device Pick box. This IF condition will be TRUE if the state of the X10 Device is the same as the state chosen from the dialog box. After completing the form, press [OK] to enter the new information into the schedule, [ADD] to enter the new information and return to the X10 Device pick box for more entries, or the [CANCEL] to escape without saving anything.

What is it The Powerline is monitored and as X10 commands are received, it updates its internal state table of all 256 X10 devices. The three states that are kept track of are ON, OFF and IDLE. You can compare the state of any X10 device to trigger an Event.

How Used When used in the schedule, the controller will compare the state of the X10 device stored in its memory, against the state chosen in the dialog box. If the states match, this IF statement will be true.

<u>Menu Choices</u>	<u>Description</u>
ON	If the device chosen is 'ON', this statement will be true.
OFF	If the device chosen is 'OFF', this statement will be true.
IDLE	If the device selected is in 'IDLE' mode, this statement will be true.
NOT OFF	This condition will be true if the specified module (house and unit code) is either ON or IDLE. It will be false if the module is OFF.
NOT ON	This condition will be true if the specified module (house and unit code) is either OFF or IDLE. It will be false if the module is ON.
NOT IDLE	This condition will be true if the specified module (house and unit code) is either ON or OFF. It will be false if the module is IDLE.
Enabled	This condition will be true if the specified module (house and unit code) is ENABLED in the DEFINE-X10 DEVICE database . It will be false if the module is DISABLED.
Disabled	This condition will be true if the specified module (house and unit code) is DISABLED in the DEFINE-X10 DEVICE database . It will be false if the module is ENABLED.
DimLevel ==##	This condition will be true if the specified module's (house and unit code) current level (0 to 10) is equal to ## (specified number). It will be false if not.
DimLevel <= ##	This condition will be true if the specified module's (house and unit code) current level (0 to 10) is less than or equal to ## (specified number). It will be false if the level is greater than ##.
DimLevel >= ##	This condition will be true if the specified module's (house and unit code) current level (0 to 10) is greater than or equal to ##. It will be false if the level is less than ##.
PresetLevel ==##	This condition will be true if the specified module's (house and unit code) Preset level (1 to 31) is equal to ## (specified number). It will be false if not.
PresetLevel <=##	This condition will be true if the specified module's (house and unit code) Preset level (1 to 31) is less than or equal to ## (specified number). It will be false if not.
PresetLevel >=##	This condition will be true if the specified module's (house and unit code) Preset level (1 to 31) is greater than or equal to ## (specified number). It will be false if not.

What is the IDLE State:

The controller keeps track of the current state of all 256 X10 devices in a place called a state table. The device state can be ON, OFF, or IDLE. A visual readout of the state table is provided by the MegaController display.

The ON or OFF state is obvious, but what is this IDLE state, and why is it needed? It can't be sent or received on the power line, it isn't part of the X10 modules or controllers, and it only exists inside the controller, yet it's extremely important and useful.

In concept, IDLE is neither ON nor OFF, but more like an "available for use" or "ready to go" state. The nature of X10 and some practical uses make it an ideal solution for a large number of situations.

When the controller passes through your schedule, one primary job it has is to look for a change in the states of the X10 devices. If it sees a change, it does whatever you told it to do. If nothing has changed, it ignores that scene or event and continues on. If it didn't act only on change of state, it would be sending out commands all the time.

Suppose you have the 8 button wireless remote control and the plug-in base receiver set for the M HouseCode. You decide that when button 5 is pressed on or off, you want the study light and the fireplace spotlight to turn on or off. Wall switches control them both across the room, one assigned A-7, and one assigned G-3 (doesn't matter what they are assigned to!).

This is easy to program. Basically, you put it in like this:

Example 12.1. EVENT Sample On

```
If
  (X: Switch 1 M-5) is ON
Then
  (X: Study Light A-7) ON
  (X: Hallway Light A-2) ON
End
```

```
EVENT Sample Off
If
  (X: Switch 1 M-5) is OFF
Then
  (X: Study Light A-7) OFF
  (X: Hallway Light A-2) OFF
End
```

Fine. Flows logically, easy to setup. You push button M-5 to ON, and they both turn on. You push M-5 to OFF, and they both turn off. How is the controller interpreting this? It received M-5 ON, from your wireless controller, which was a change to the state of M-5, so it rolled along turning on the lights you assigned on the other codes. The controller passes through the schedule many times a second, watching for a change to the state of M-5. The next pass through your schedule, it checked M-5 for it's current state (ON). Until it sees M-5 change, it doesn't try to turn on the lights again.

Now to turn the lights off. You push button M-5 to OFF, and they both turn off. When you sent M-5 OFF, the controller received it and saw the change in the state of M-5, so it turned off both lights. Next time through the schedule, it left everything alone.

So, it works the way you expect. What's the problem? Where's that IDLE state stuff come in? Let's throw in a typical monkey wrench. Your four-year old boy zips in while you're still sitting there and punches the wall switch for the study light, flipping it off manually. You push the button M-5 ON on your controller like you did originally, but this time the lights don't come on. Nothing happens. You try pushing it ON again a couple times, still nothing. You push it OFF, and now the remaining light goes off. Now you push M-5 ON again, and finally both lights go ON. What's going on here?

A limitation of X10 devices is that most are one-way, which means they can't notify the controller when they are turned on or off manually! The controller was still watching for a change to the state of M-5 (ON, in the example). When you pressed M-5 ON to flip the light back on that your child turned off manually, the controller checked M-5, found it set to ON already, so it didn't try to turn on the lights again. Not until you pushed it off, changing the state, did it act on it.

So why not always act on M-5 ON, every pass through the schedule, instead of watching for the change in its state? In this example, it would then send an 'ON' command to the two lights, constantly, every pass through the schedule. You wouldn't be able to turn off the lights manually, not to mention the power line tied up with constant X10 commands.

You could do some clever programming, setting flags and such, to get around this X10 limitation, but it would be complicate things quite a bit. Enter the IDLE state. If you could set the M-5 button to IDLE, which is neither ON nor OFF, it would then be available for use . A push of M-5 ON at any time, (like after the child turned off the wall switch manually) would then be a change in the state of M-5 (from IDLE to ON) and the controller would re-send the commands to turn the lights on.

Let's rewrite the example to set the state of M-5 to IDLE after each push:

Example 12.2. EVENT Sample On (Version 1)

```
If
  (X: Switch 1 M-5) is ON
Then
  (X: Study Light A-7) ON
  (X: Hallway Light A-2) ON
  (X: Switch 1 M-5) Idle
End
```

EVENT Sample Off

```
If
  (X: Switch 1 M-5) is OFF
Then
  (X: Study Light A-7) OFF
  (X: Hallway Light A-2) OFF
  (X: Switch 1 M-5) Idle
End
```

Now each time that you push M-5 on your wireless controller, it re-sends the ON or OFF commands to your lights, even if they have been turned on or off manually. Since your event always sets the M-5 to IDLE state after each time you push the button, any M-5 ON or OFF code coming in is a change to the M-5 state, so it will trigger the event.

You will find having the ability to set switches (such as M-5 in the example) and devices to the IDLE state (making them available to be triggered), will make writing events into your schedule much easier than the fancy programming necessary to otherwise cope with X10 limitations.

Another way to write this example would be to use the X10 Sequence. When an Event is using an X10 Sequence, it is waiting for an exact sequence of X10 Commands on the Powerline, and they must happen within a certain amount of time.

Using X10 Sequences in the previous example, the IDLE state is not needed. This is because the Event is looking for a sequence of X10 commands, not a state change, so there is no need to change the state of anything.

Let's rewrite the example to look for a sequence instead of a state change:

Example 12.3. EVENT Sample On (Version 2)

```
If
  (XSEQ: M-5 M-ON) received within 4 seconds
Then
  (X: Study Light A-7) ON
  (X: Hallway Light A-2) ON
End
```

EVENT Sample Off

```
If
  (XSEQ: M-5 M-OFF) received within 4 seconds
Then
  (X: Study Light A-7) OFF
  (X: Hallway Light A-2) OFF
End
```

Now each time that you push M-5 (sending M-5 M-ON) on your wireless controller, the controller sees the sequence and re-sends the ON commands to your lights, even if they have been turned on or off manually.

X10 State vs. X10 Sequence

X10 State: The present status, ON/OFF/Idle, of the X10 device at the time it is looked at it in a schedule.

X10 Sequence: A series of any valid X10 transmissions, either HouseCode/UnitCode or HouseCode/FunctionCode, which the controller receives.

IF- X10 Sequence

Selecting X10 Sequence from the menu will open the X10 Sequence Box. This IF condition will be TRUE if the controller receives or transmits the X10 Command sequence, in the exact order and within the time window that you specify in the dialog box. After completing the form, press the [OK] button to enter the new information into the schedule, or [CANCEL] to return without saving.

What is it The Powerline is monitored and compares received only, transmitted only, or either received/transmitted commands on the Powerline with the command(s) that you specify in the X10 Sequence box. A command sequence can consist of up to 6 X10 commands and a time window that they must occur in. An X10 command sequence can consist of any X10 commands, A1, C5, P-ON, F-OFF, D-ALL UNITS OFF, etc.

How Used When used in the schedule, the controller will monitor the Powerline and if the X10 commands received are the same as those you have specified, and they occur within the time window, this statement will be TRUE.

Menu Choices	Description
HouseCode	The HouseCode used in the command
UnitCode	The UnitCode used in the command if the UnitCode radio button is chosen
UnitCode	Select a UnitCode command
ON Command	Select the ON command
OFF Command	Select the OFF command
Dim Command	Select the DIM command
Bright Command	Select the BRIGHT command
All Lights ON	Select the All Lights ON command
All Lights OFF	Select the All Lights OFF command
All Units OFF	Select the All Units OFF command
Preset Command	Select the Preset command and a preset level
Time Window	The Time frame that the commands must occur in. Note that each X10 command takes approximately 1 second to send if sent with no delay in-between, so be sure to allow enough time for all of the commands to be seen in the Time Window
[Add]	This will add a command to the X10 Sequence list where the highlight bar is positioned
[Replace]	This will replace a command in the X10 Sequence list where the highlight bar is positioned with selections made
[Delete]	This will delete the command that is highlighted in the list box
[OK]	This will accept the choices made and add to the schedule
[Cancel]	This will exit the X10 Sequence dialog box without adding or modifying the schedule

Example 12.4. EVENT: lights 1 (Using 1 UnitCode to control 4 different lights)

```

If
  (XSEQ: A-1 A-OFF A-1 A-OFF) Received within 4 seconds
Then
  (X:Lamp 1 B 1) ON
End

```

EVENT: lights 2

```

If

```

```

(XSEQ: A-1 A-OFF A-1 A-ON) Received within 4 seconds
Then
(X:Lamp 2 B 2) ON
End

```

```

EVENT: lights 3
If
(XSEQ: A-1 A-ON A-1 A-OFF) Received within 4 seconds
Then
(X:Lamp 3 B 3) ON
End

```

```

EVENT: lights 4
If
(XSEQ: A-1 A-ON A-1 A-ON) Received within 4 seconds
Then
(X:Lamp 4 B 4) ON
End

```

IF – Timer

What is it

These are the Timers that you have defined in the Device DataBase for use in your schedule. Timers are countdown timers, meaning, once a timer is loaded, it will decrement every second until it reaches zero (00:00:00), or is stopped by an Event. The maximum amount of time that can be loaded into a Timer is 18 hours, 12 minutes, 16 seconds (18:12:16). Once the Timer has been loaded, it will start counting down to zero (00:00:00).

There are 4 states that a Timer can be in:

Expiring: A Timer is Expiring when it changes from 00:00:01 to 00:00:00. The Timer will stay in the Expiring state for one complete pass through your Schedule, then change to the Stopped state.

Running: While a Timer is counting down, it is in the Running state.

Not Running: While a Timer is not counting down (opposite of Running).

Stopped: A Timer can get into the Stopped state 1 of 2 ways. 1) The Timer can be stopped using the Timer Stop Action in an Event, or 2) After the Timer reaches the Expiring state, it goes into the Stopped state.

Cleared: After every Schedule download, all Timers are put into the 'Cleared' state. *Note that this is different from the 'Stopped' state, it cannot be tested for in an Event.* Timers will stay in the 'Cleared' state until an Event changes its state. It may be necessary to create an 'Initialization Event' that after a download, puts the Timers into a state other than 'Cleared'.

How Used

Timers can be used in an Event to provide 1-second resolution timed events. The Timers can be stopped, started, cleared or loaded with a new countdown time at any time.

<u>Menu Choices</u>	<u>Description</u>
Expiring	If the Timer is Expiring (the Timer counts down to 00:00:00), this IF statement will be true.
Running	If the Timer is running, this IF statement will be true.
Not Running	If the Timer is NOT running, this IF statement will be true.
Stopped	If the Timer has been stopped, this IF statement will be true.

Timer States.

If a Timer is loaded with 15 seconds, this is the sequence of timer states.

<u>Timer Value</u>	<u>Timer State</u>
00:00:00	Stopped
00:00:15	Running (just loaded with 15 seconds)
00:00:14	Running
. . .	
00:00:01	Running
00:00:00	Expiring (Timer stays in this state for 1 pass through schedule)
00:00:00	Stopped

Example 12.5. Timer Initialization

```

EVENT: Initialization Event
If
  (X: N-16) is ON
  or (X: N-16) is OFF
Then
  (T:HallwayLt) STOP
End

```

Example 12.6. If/Then with Timer operation

```

EVENT: Hallway Motion
If
  (XSEQ: A-14 A-ON) Received within 4 seconds
Then
  (T:HallwayLt) Load 0:02:00
  (X:Hall Light) ON
End

```

```

EVENT: Hallway Turn OFF
If
  (T:HallwayLt) is Expiring
Then
  (X:Hall Light) OFF
End

```

In this example, when motion is detected in the hallway, the X10 command A-14 A-ON is sent. When this command is received, the “HallwayLt” timer gets loaded with 2 minutes and the hallway light turns ON (in EVENT “Hallway Motion”). When the timer reaches 0:00:00 (Expiring), the second EVENT “Hallway Turn OFF” will turn the hallway light OFF.

NOTE: Timers are re-triggerable, that is, while they are running, a new load value can be loaded into the timer. In the previous example, if the timer had counted down to say, 10 seconds, and there was motion in the hallway again causing the A-14 A-ON command to be sent again, the “HallwayLt” timer would be reloaded with 2 minutes.

IF - Flag

What is it Flags are variables that have 3 states, Set , Clear or IDLE. Events can use Flags to communicate with each other.

How Used When used in the schedule, the state of the Flag will be compared to that specified.

Menu Choices Description

Set If the Flag’s state is Set, this IF statement will be true

Clear If the Flag’s state is Clear, this IF statement will be true

IDLE	If the Flag's state is IDLE, this IF statement will be true
Not Set	If the Flag's state is NOT Set, this IF statement will be true
Not Clear	If the Flag's state is NOT Clear, this IF statement will be true
Not IDLE	If the Flag's state is NOT IDLE, this IF statement will be true

Example 12.7. Tracking System

```

EVENT: Tracking 1
If
  (X:Hall Motion A-14) is ON
Then
  (F:Hallway Track) SET
End

EVENT: Tracking 2
If
  /* going from hallway to study */
  (X:Study Motion) is ON
  and (F:Hallway Track) is SET
Then
  (X:Hall Light) OFF
  (X:Study Light) ON
  (F:Hallway Track) CLEAR
  (F:Study Track) SET
End

EVENT: Tracking 3
If
  /* going from study to hallway */
  (X:Hall Motion A-14) is ON
  and (F:Study Track) is SET
Then
  (X:Study Light) OFF
  (X:Hall Light) ON
  (F:Study Track) CLEAR
  (F:Hallway Track) SET
End

```

In the tracking example above, flags are used to keep track of the last room that was occupied. Using motion detectors and keeping track of the last room that was occupied (with flags), a sophisticated tracking system can be developed that will turn the lights on in the room that you walk into, as well as turn off the lights in the room you were just in.

IF - Variable

<i>What is it</i>	Variable values can range anywhere from 0 to 255. The Variable can be compared against a value, A/D Input, HVAC temperature or Setpoint, or another Variable and used to trigger an Event.
<i>How Used</i>	When used in the schedule, the Variable will be compared against the type that you specify.

Compare Options

Equal to	Variable is equal to
Less than	Variable is less than
Greater than	Variable is greater than

Less than/Equal to	Variable is less than or equal to
Greater than/Equal to	Variable is greater than or equal to
Not Equal to	Variable is not equal to
Changes Value	This condition will be true if the value changes since the last schedule pass.
Increases in Value	This condition will be true if the value has increased since the last schedule pass
Decreases in Value	This condition will be true if the value has decreased since the last schedule pass
Bits 0-7 Set	These conditions check to determine if the specified bit is set (has a value of one). Variables/Analog Inputs/HVAC values are stored as 8-bit numbers ranging from 0 to 255. Bit 0 is the least significant bit (LSB) and bit 7 is the most significant bit (MSB). Here are some examples: If the variable = 0(decimal) (00000000b), no bits are set. If the variable = 8(decimal) (00001000b), only bit 3 is set. If the variable = 6(decimal) (00000110b), bits 1, and 2 are set. If the variable = 192(decimal) (11000000b), bits 7 and 6 are set.
Bits 0-7 Not Set	These conditions check to determine if the specified bit is NOT set (has a value of zero). Variables /Analog Inputs/HVAC values are stored as 8-bit numbers ranging from 0 to 255. Bit 0 is the least significant bit (LSB) and bit 7 is the most significant bit (MSB).

Compare Against

Value	If selected, the Variable highlighted in the listbox will be compared against a value that can range from 0 to 255 (see picture above).
Analog Input	If selected, the Variable highlighted in the listbox will be compared against an Analog Input shown in the listbox to the right.
Variable	If selected, the Variable highlighted in the listbox will be compared against a Variable picked from the listbox to the right.
HVAC	If selected, the Variable highlighted in the listbox will be compared against an HVAC value shown in the listbox to the right.

IF – Macro

<i>What is it</i>	An IF Macro is a set of IF Conditions that has a name (like an Event with no THEN actions) and can be used multiple times in a Schedule. Each IF Macro has a logic type associated with it, similar to the logic type of an Event. If the logic type is AND, then all of the conditions must be true for the IF Macro to be true. If the logic type is OR, then only 1 of the conditions needs to be true for the IF Macro to be true.
<i>How Used</i>	When used in the schedule, the controller will evaluate all of the IF Conditions in the IF Macro. If the conditions meet the requirements of the IF Macro (AND/OR), the IF Macro statement will be true.

Example 12.8. IF Macro Example: Gone@Night.

```
IF MACRO:
If
(X:Alarm Armed) is ON
and After SunSet SMTWTFS
End
```

Example 12.9. Using IF Macro “Away at Night”.

```
EVENT: Random Lights1
```

```

If
  (IF MACRO:Gone@Night)
  and Time is 8:30 PM SMTWRFS Security Mode
Then
  (X:Kitchen Lights) ON
End

```

```

EVENT: Random Lights2
If
  (IF MACRO:Gone@Night)
  and Time is 9:30 PM SMTWRFS Security Mode
Then
  (X:Dining Lights) ON
End

```

In the examples above, an IF MACRO was used by both Events to check if the Alarm is Armed and if it is dark outside. Once you define an IF MACRO, you may use it in any Event, any number of times.

~~IF~~ Comment

What is it A Comment can be a description or a note. It does not affect the way the Event works in any way.

How Used When used in the schedule, a Comment can add some description of what the Event is doing. A Comment can be placed anywhere within the Event, but not between Events.

IF – Time

What is it A Time condition is a time that you want something to happen.

How Used When used in the schedule, THE CONTROLLER will compare the current time of day to the time you choose. If the times match, the IF statement will be TRUE.

<u>Menu Choices</u>	<u>Description</u>
Equal to	If the “Equal to” radio button is pressed, the current time must be equal to the time you have entered and match the days you chose in order to be considered true.
Before	If the “Before” radio button is pressed, the current time must be AFTER Midnight <u>and</u> BEFORE the specified time , and match the days you chose, in order to be considered true.
After	If the “After” radio button is pressed, the current time must be AFTER the specified time <u>and</u> BEFORE Midnight (11:59:59 PM), and match the days you chose, in order to be considered true.
Days	By selecting the checkbox next to the days, you can specify the day(s) this condition must occur.

Security Mode Security Mode will add or subtract a random amount of time from the time entered. Every day a new random number is generated and added to the time entered. This feature is useful to make lights go on or off at random times to give a more ‘lived in’ look.

The controller’s day begins at midnight and ends at 11:59 PM. If you are using an IF statement such as ‘Time is after 8:00 PM’, it will be true from 8:00 PM until midnight (when it’s day ends).

As an example, Otto would like to turn his outdoor lights on when he presses the button on his mini-controller, but only if it is at night (after 8:00PM for this example).

Example 12.10. EVENT Outdoor lights

```
If
  Time is After 8:00 PM SMTWTFS
  and (X:minibutton) is ON
Then
  (X:Outdoorlghts) ON
End
```

This is fine until Otto stays up after midnight one evening. Once the time is after midnight (11:59 PM), he could not turn his lights on. He solved this by adding another Time condition to his Event.

Example 12.13. EVENT Outdoor lights

```
If
  Time is After 8:00 PM SMTWTFS
  or Time is Before 6:00 AM SMTWTFS
  -AND-
  (X:minibutton) is ON
Then
  (X:Outdoorlghts) ON
End
```

Now, if is after 8pm or before 6am, and Otto presses the button, his light will turn on.

NOTE: You must use OR logic when times cross over midnight to the next day.

IF - Time Label

What is it A Time Label is a time that has descriptive name. It can be used to give a meaningful name to a particular time.

Example: “Wakeup” could mean 5:45 AM . MTWTF .

 “Dusk” could mean 30 minutes after SunSet

How Used When used in a schedule, the current time of day will be compared to the time in the Time Label. If the times meet the requirements that have been entered into the Time Label, the IF statement will be TRUE.

Menu Choices Description

Equal To The current time and day must EQUAL the TimeLabels time and day exactly.

Before If selected, the current time must be **AFTER Midnight** and **BEFORE the TimeLabels time** and the days must match.

After If selected, the current time must be **AFTER the TimeLabels time** and **BEFORE Midnight** and the days must match.

IF – Date

What is it Dates are a particular Month and Day. They are used to control an Event's actions to a particular day of the year, or a range of days. An example would be changing heating and cooling patterns based on the seasons.

How Used When used in the schedule, THE CONTROLLER will compare the current date against the month and day that you have specified into your schedule.

Menu Choices Description

- Equal To Date** When the current date becomes **EQUAL** to the date specified, this IF statement will be TRUE.
- Before Date** When the current date is **AFTER January 1st** and **BEFORE the specified date**, this IF statement will be TRUE, otherwise it is FALSE.
- After Date** When the current date is **AFTER the specified date** and **BEFORE January 1st**, this IF statement will be TRUE, otherwise it is FALSE.
- Even Days** Condition is true if the current day of the month is an even number (2,4,6, etc.).
- Odd Days** Condition is true if the current day of the month is an odd number (1,3,5, etc.).
- Season – Spring** Condition is true if the current date is between March 20 and June 20.
- Season – Summer** Condition is true if the current date is between June 21 and September 21.
- Season – Fall** Condition is true if the current date is between September 22 and December 20.
- Season – Winter** Condition is true if the current date is between December 21 and March 19.
- AM** Condition is true if current time is between 12:00 AM (midnight) and 11:59 AM.
- PM** Condition is true if current time is between 12:00 PM (noon) and 11:59 PM.
- Daytime** Condition is true if current time is between 6:00 AM and 5:59 PM.
- Nighttime** Condition is true if current time is between 6:00 PM and 5:59 AM.
- Light** Condition is true if current time is after sunrise and before sunset.
- Dark** Condition is true if current time is after sunset and before sunrise.

As an example, Otto would like his Christmas lights to come on at 6:00 PM everyday if it's after December 15th.

Example 12.14. EVENT Christmaslights

```

If
  Date is After Dec 15
  and Time is 6:00 PM SMTWTFS
Then
  (X:Christmaslghts) ON
End

```

The Christmas lights would be turned on at 6:00 PM everyday as long as it is after December 15th. When the date becomes January 1st, the lights would not be turned on since this is the start of another year.

If Otto wanted to have his lights come on from December 15th - January 5th, his Event would look like this:

Example 12.15. EVENT Christmaslights

```

If
  Date is After Dec 15
  or Date is Before Jan 5
  -AND-
  Time is 6:00 PM SMTWTFS
Then
  (X:Christmaslghts) ON
End

```

Note: You must use OR logic when dates cross over to the next year.

IF - SunRise/SunSet

Selecting SunRise/SunSet from the menu will open the SunRise/SunSet box. You can choose to have this IF condition be TRUE if the current time is Equal to, Before or After SunRise or SunSet on a particular day. After completing the form, press the [OK] button to enter the new information into the schedule, or the [CANCEL] to return without saving anything.

What is it Everyday at midnight, the controller re-calculates the SunRise and SunSet times, based on your location. Your schedule can use these times to control Events that you want to be based on SunRise or SunSet times. The calculated SunRise and SunSet times has an accuracy of plus or minus 10 minutes from the true SunRise or SunSet.

How Used When used in the schedule, the controller will compare it's current time to the calculated SunRise or SunSet time and also compare the current day of the week.

<u>Menu Choices</u>	<u>Description</u>
Equal To	If the current time is EQUAL to the SunRise or SunSet time on the day(s) selected, this IF statement will be true.
Before	If the current time is AFTER Midnight <u>and</u> BEFORE the SunRise or SunSet time on the day(s) selected, this IF statement will be true.
After	If the current time is AFTER the SunRise or SunSet time <u>and</u> BEFORE Midnight on the day(s) selected, this IF statement will be true.
SunRise	If selected, it will use the calculated SunRise time in this statement.
SunSet	If selected, it will use the calculated SunSet time in this statement.
[]Security Mode	When selected, the will add the security offset to the SunRise or SunSet time. This will change the SunRise/SunSet time by adding/subtracting the Security Offset to the time.

Note: For SunRise/SunSet calculations to be accurate, the Longitude, Latitude and Time Zone information must be correct.

IF- ASCII In

What is it ASCII text data can be sent to the controller and used to trigger an Event. The ASCII text can be up to 32 characters in length and must be terminated with a carriage return.

How Used The ASCII text sent to the controller can **match exactly** (upper/lower case, spaces, etc.), match a range of characters or test for a number of characters. Programs other than Event Manager can send ASCII text to the controller to trigger Events. Select the controller COM port ("Source") that will receive the ASCII data.

<u>Menu Choices</u>	<u>Description</u>
Input Data Match	The ASCII input string must match exactly (upper/lower case, spaces, etc.) the ASCII In statement

Input Data Range Match This condition is used to compare the input string or a portion of it to certain characters.

Example: Match 'ZZZZZ' starting at char X

The symbol meanings are:

X refers to the location in the string of the first character to compare (i.e., the character number).

ZZZZZZZZ are the characters to compare the received data to. The condition is true if all characters match exactly, false is any do not match.

Number of characters received equals ##

Condition is true if the number of characters received (serial string length) is equal to the value.

Number of characters received is less than ##

Condition is true if the number of characters received (serial string length) is less than or equal to the value.

Number of characters received is greater than ##

Condition is true if the number of characters received (serial string length) is greater than or equal to the value.

Example 12.16. ASCII In.

```
EVENT: ASCII Input Example
If
  ASCII-In: 'Hello Otto' [COM 1]
Then
  (X:Study Light A7) ON
End
```

In the previous example, when the ASCII text 'Hello Otto' is sent to the controller, it will trigger the Event to turn the Study Light ON.

Suppose an alarm system sends ASCII text messages for its alarm states. Typical messages the alarm would send are:

- Alarm Violation
- Alarm Armed
- Alarm Ready

To keep track of Alarm states, ASCII In conditions are used.

Example 12.17. ASCII In.

```
EVENT: Alarm Status
If
  ASCII-In: Match 'Alarm' starting at character number 1[COM1]
Then
  /-If
  / ASCII-In: Match 'Armed' starting at character number 7[COM1]
  /Then
  / " Armed state == 1 "
  / (V:Alarm State) ) LOAD with 1
  /-End
  /-If
  / ASCII-In: Match 'DisArmed' starting at character number 7[COM1]
  /Then
  / " Disarmed state == 2 "
  / (V:Alarm State) ) LOAD with 2
  /-End
```

```

/-If
/ ASCII-In: Match 'Violated' starting at character number 7[COM1]
/Then
/ " Violated state == 3 "
/ (V:Alarm State) ) LOAD with 3
/-End
End

```

Suppose you have a weather station that reports the current temperature in the following format:

Temp = 85 degrees

To match the string and convert the value to a variable the following event could be used.

Example 12.18. ASCII In.

```

EVENT: Convert Temperature
If
  ASCII-In: Match 'Temp = ' starting at character number 1[COM1]
Then
  Put value of received char #8-9 into user_VAR [COM1]
  (V:Temperature) load with user_VAR
End

```

Note: The serial port of the controller will not echo any ASCII text that is sent to it. The ASCII text input to the controller must be terminated with a carriage return (linefeeds are not needed).

IF- OR

Selecting OR Statement from the menu will add an OR statement to the Event.

What is it OR statements are used in AND type Events.

How Used You can use the OR statement to create compound AND/OR type Events.

Example 12.19. OR Statement.

```

EVENT: OR/AND Example
If
  (X:P1 ) is ON
  and (X: P2 ) is ON
  -OR-
  (X:P3 ) is ON
  and (X: P4 ) is ON
Then
  (X: B7) ON
End

```

In the previous AND/OR example, if P1 and P2 is ON, OR, if P3 and P4 is ON, then turn B7 ON.

IF - AND

Selecting AND Statement from the menu will add an AND statement to the Event.

What is it AND statements are used in OR type Events.

How Used You can use the AND statement to create compound OR/AND type Events.

Example 12.20. AND Statement.

```

EVENT: OR/AND Example
If
  (X:P1 ) is ON
  or (X: P2 ) is ON
  -AND-
  (X:P3 ) is ON
  or (X: P4 ) is ON
Then
  (X: B7) ON
End

```

In the previous OR/AND example, if either P1 or P2 is ON, AND, if either P3 or P4 is ON, then turn B7 ON.

IF - System Variable

What is it System Variables are variables internal to the controller that can be used in Schedules.
How Used The System Variables can be used to trigger an Event

<u>Menu Choices</u>	<u>Description</u>
Power-Restore	This variable is set after power is restored after a power failure. It will be set for one pass through the Schedule, then it will be cleared. You may want to use this variable to force certain devices to an known state after power comes back on.
First Pass	This variable is for the first pass through a Schedule after a DownLoad. You may want to use this variable to force certain devices to an known state after a new DownLoad.
X10 Signal Loss	This variable is set when the X10 zero cross signal is not received. This can occur if the TW523 PLI is unplugged or if the AC power powering the TW523 goes out. This variable could be used to detect a power failure if running on battery backup.

Example 12.21. Power Restore.

```

EVENT: Power Restore Example
If
  Power-Failure
Then
  /* Reset critical Devices */
  (X:Hot Tub B-5) OFF
  (X:Sprinklers D-1) OFF
End

EVENT: First Pass Example
If
  First Pass
Then
  /* Setup Certain Devices */
  (F:Security Active) OFF
  (X:Modem M-1) ON
End

EVENT: X10 Loss Example
If
  X10 Loss
Then
  LOG ' AC Power Loss'
End

```

IF - Digital Input

What is it Digital Inputs are 'ON' when sufficient voltage (4 - 24v ac or dc) is applied between the two inputs when configured in voltage mode, or when configured for switch input, an electrical connection is made between the two inputs.

How Used When used in a schedule, the controller will compare if the condition is met, then the IF statement will be TRUE.

Menu Choices Description

ON	This IF statement will be TRUE as long as a voltage is applied to the Digital Input selected in the list box.
OFF	This IF statement will be TRUE as long as there is <u>no</u> voltage to the Digital Input selected in the list box.
Toggle	The IF statement will be TRUE if the Digital Input changes from either ON to OFF or OFF to ON, it doesn't matter which way it changes, only that it did change.
Goes ON	This IF statement will be TRUE when a voltage is first applied to the Digital Input selected in the list box. It is equivalent to TOGGLES and IS ON.
Goes OFF	This IF statement will be TRUE when a voltage is first removed from the Digital Input selected in the list box. It is equivalent to TOGGLES and IS OFF.

IF - Analog Inputs

What is it An Analog Input measures voltages that range from 0 to 5 volts DC. The converted value can range anywhere from 0 to 255. The Analog value can be compared against a value, Analog Input, HVAC temperature or Setpoint, or Variable and used to trigger an Event.

How Used When used in the schedule, the Analog Input will be compared against the type that you specify.

Compare Options

Equal to	Analog Input is equal to
Less than	Analog Input is less than
Greater than	Analog Input is greater than
Less than/Equal to	Analog Input is less than or equal to
Greater than/Equal to	Analog Input is greater than or equal to
Not Equal to	Analog Input is not equal to
Changes Value	This condition will be true if the value changes since the last schedule pass.
Increases in Value	This condition will be true if the value has increased since the last schedule pass
Decreases in Value	This condition will be true if the value has decreased since the last schedule pass
Bits 0-7 Set	<p>These conditions check to determine if the specified bit is set (has a value of one). Variables/Analog Inputs/HVAC values are stored as 8-bit numbers ranging from 0 to 255. Bit 0 is the least significant bit (LSB) and bit 7 is the most significant bit (MSB). Here are some examples:</p> <p>If the Analog Input = 0(decimal) (00000000b), no bits are set.</p> <p>If the Analog Input = 8(decimal) (00001000b), only bit 3 is set.</p>

If the Analog Input = 6(decimal) (00000110b), bits 1, and 2 are set.

If the Analog Input = 192(decimal) (11000000b), bits 7 and 6 are set.

Bits 0-7 Not Set

These conditions check to determine if the specified bit is NOT set (has a value of zero). Variables /Analog Inputs/HVAC values are stored as 8-bit numbers ranging from 0 to 255. Bit 0 is the least significant bit (LSB) and bit 7 is the most significant bit (MSB).

Compare Against

- Value** If selected, the Analog Input highlighted in the listbox will be compared against a value that can range from 0 to 255 (see picture above).
- A/D Device** If selected, the Analog Input highlighted in the listbox will be compared against an A/D input shown in the listbox to the right.
- Variable** If selected, the Analog Input highlighted in the listbox will be compared against a Variable picked from the listbox to the right.
- HVAC** If selected, the Analog Input highlighted in the listbox will be compared against an HVAC value shown in the listbox to the right.

IF - Relay State

- What is it* The state of a Relay Output can be compared and used in a schedule.
- How Used* When used in a schedule, the controller will test the state of a Relay.

Menu Choices Description

- ON** This IF statement will be TRUE if the Relay is in the ON state.
- OFF** This IF statement will be TRUE if the Relay is in the OFF state.

IF- IR

- What is it* When used in conjunction with the JDS InfraRed Xpander™, received Infrared Command Sequences and Power Sensor Input states can be compared. The controller monitors the InfraRed Xpander™ and compares Infrared commands received with the command(s) that you specify in the IR Sequence box. A command sequence can consist of up to 10 commands and a time window that they must occur in. An IR command sequence can consist of any learned IR commands.
- How Used* First, configure the InfraRed Xpander™ using the Define | IR & IO | IRXpander setup screen. IR Sequences can be used after IR codes have been learned into the InfraRed Xpander™. IR Power Sensor states can be used after names have been assigned to the ports.

IR Sequence

An IR sequence is a number of IR commands received by the InfraRed Xpander™ within a time window.

IR Power Sensor

IR Power Sensors can be tested for ON and OFF states.

IF - HVAC

These are the Thermostats that you have defined in Define | HVAC.

- What is it* The Thermostat's Setpoint and Temperature can be compared against a value, Analog Input, another HVAC temperature or Setpoint, or Variable and used to trigger an Event.
- How Used* When used in the schedule, the Thermostat's Setpoint or Temperature will be compared against the type that you specify.

Compare Options

- | | |
|------------------------------|--|
| Equal to | Setpoint or Temperature is equal to |
| Less than | Setpoint or Temperature is less than |
| Greater than | Setpoint or Temperature is greater than |
| Less than/Equal to | Setpoint or Temperature is less than or equal to |
| Greater than/Equal to | Setpoint or Temperature is greater than or equal to |
| Not Equal to | Setpoint or Temperature is not equal to |
| Changes Value | This condition will be true if the value changes since the last schedule pass. |
| Increases in Value | This condition will be true if the value has increased since the last schedule pass |
| Decreases in Value | This condition will be true if the value has decreased since the last schedule pass |
| Bits 0-7 Set | These conditions check to determine if the specified bit is set (has a value of one). Variables/Analog Inputs/HVAC values are stored as 8-bit numbers ranging from 0 to 255. Bit 0 is the least significant bit (LSB) and bit 7 is the most significant bit (MSB). Here are some examples: |

If the Setpoint or Temperature = 0(decimal) (00000000b), no bits are set.

If the Setpoint or Temperature = 8(decimal) (00001000b), only bit 3 is set.

If the Setpoint or Temperature = 6(decimal) (00000110b), bits 1, and 2 are set.

If the Setpoint or Temperature = 192(decimal) (11000000b), bits 7 and 6 are set.

Bits 0-7 Not Set These conditions check to determine if the specified bit is NOT set (has a value of zero). Variables /Analog Inputs/HVAC values are stored as 8-bit numbers ranging from 0 to 255. Bit 0 is the least significant bit (LSB) and bit 7 is the most significant bit (MSB).

Compare Against

Value If selected, the Setpoint or Temperature highlighted in the listbox will be compared against a value that can range from 0 to 255 (see picture above).

A/D Device If selected, the Setpoint or Temperature highlighted in the listbox will be compared against an A/D input shown in the listbox to the right.

Variable If selected, the Setpoint or Temperature highlighted in the listbox will be compared against a Variable picked from the listbox to the right.

HVAC If selected, the Setpoint or Temperature highlighted in the listbox will be compared against an HVAC value shown in the listbox to the right.

IF - Telephone

The Telephone menu has two fields: Telephone Sequence and C.O. Line Status.

The Telephone Sequence field lets you program events to respond to sequences of TouchTones, off-hook and on-hook signals.

The C.O. Line Status field lets you program events to respond to off-hook, on-hook, hold, ring(s), Caller ID, Remote User, TouchTone to user_VAR and TouchTone to TimeLabel done.

To add a Telephone Condition to an event:

- 1) Click on the IF line of the event then click on ADD.
- 2) Click TELEPHONE.
- 3) Click the desired sequence of TouchTones, off-hook, and on-hook signals to respond to.

To program a response to any TouchTone digit, click the ANY TOUCHTONE button.

- 4) Click OK. A "Telephone" line will appear in the IF section of the event.

Note: Off-Hook is represented by "^", On-Hook by "+", Any TouchTone by "?".

Telephone Sequence

Telephone Sequences can be based upon any TouchTone digit or ONHook/OFFHook states.

Telephone Status

CO OFFHook Condition is true when the CO Line is in the OFFHook state (a phone is off the hook).

CO ONHook Condition is true when the CO Line is in the ONHook state (a phone is on the hook).

CO Off Hold Condition is true when the CO Line is not in the Hold state.

CO On Hold Condition is true when the CO Line is in the Hold state.

ICM OFFHook	Condition is true when a phone connected to the ICM port is in the OFFHook state (a phone is off the hook).
ICM ONHook	Condition is true when a phone connected to the ICM port is in the ONHook state (a phone is on the hook).
Ring	Condition is true the number of Rings specified equals the number of rings of an incoming call.

TouchTone to user_VAR done

Condition is true when the TouchTone to user_VAR conversion is completed. The TouchTone to user_VAR conversion is completed when 1 - 3 TouchTone digits followed by the pound (#) digit is entered. The conversion is aborted if a) an ONHook condition occurs before pound digit entered, b) 10 seconds elapse after the start of the conversion, c) a value greater than 255 is entered. If aborted, the user_VAR value will be loaded with 255.

Typical uses for this condition is to load another variable or HVAC SetPoint after a successful conversion.

TouchTone to TimeLabel done

Condition is true when the TouchTone to TimeLabel conversion is completed. The TouchTone to TimeLabel conversion is completed when 1 - 4 TouchTone digits followed by the star (*) digit for AM or the pound (#) digit for PM is entered. The conversion is aborted if a) an ONHook condition occurs before the star or pound digit is entered, b) 10 seconds elapse after the start of the conversion, c) an invalid time is entered. If aborted, the Time Label will not be loaded.

Typical use for this condition is to load and announce the TimeLabel after a successful conversion.

CID Match Condition is true when an incoming call's Caller ID number matches the number entered. A question mark can be used as a wild character to match any digit.

CID Unknown Number Condition is true when an incoming call's Caller ID number is reported as an Unknown Number. This can occur when a call is coming from an area that does not support Caller ID.

CID Private Number Condition is true when an incoming call's Caller ID number is reported as a Private Number. This can occur when the person originating the call blocks the Caller ID information.

Example 12.22. HOOKFLASH MANIA.

With this event, if you pick up then hang up the phone three times within 6 seconds, the controller will turn off all the lights.

```

EVENT: Hookflash Mania
  If
    Telephone Seq: ' ^ + ^ + ^ + ' is Received within 6 seconds
  Then
    (XCMD: A All-Units-Off)
  End

```

Example 12.23. CALLER ID ANNOUNCE.

In the following example, the controller's Caller ID identifies an incoming call and announces the caller through the speaker. It then answers the call and plays a message to the caller. An on-hook signal is issued after 3 minutes to prevent tying up the C.O. line.

```

EVENT: CALLER ID JOHN
  If
    CallerID: 212-555-1212
  Then
    Voice: "It's John, Pick Up" [SPEAKER]
    Telephone: OFF-HOOK
    Voice: "Hi John, hold on, I'll be right there" [C.O. Line]

```

Delay 0:03:00
Telephone: ON-HOOK
End

Example 12.24. VOICE PAGING.

In this example, picking up a phone (^), then pressing *72 will connect the Intercom to the Speaker Output to allow live voice paging until the phone is hung up (+).

```
EVENT: ACTIVATE PAGING
If
  Telephone Seq: '^*72' is Received within 3 seconds
Then
  (AUDIO PATH: Connect Intercom to Speaker Output)
End
```

```
EVENT: DE-ACTIVATE PAGING
If
  Telephone Seq: '+' is Received within 1 seconds
Then
  (AUDIO PATH: Disconnect Intercom to Speaker Output)
End
```

Example 12.25. LONG DISTANCE CALL ALERT.

With this event, picking up a phone (^), then pressing 1 followed by any ten TouchTone digits (??????????) within 15 seconds will turn on module A-1 for 5 seconds to indicate a long distance call is being made.

```
EVENT: Long Distance Call Alert
If
  Telephone Seq: '^1??????????' Received within 15 seconds
Then
  (XCMD: A-1 A-ON)
  Delay 0:00:05
  (XCMD: A-1 A-OFF)
End
```

IF - VoiceMail

What is it The number of messages in the various mailboxes can be compared against a value, A/D Input, HVAC temperature or Setpoint, or another Variable and used to trigger an Event.

How Used When used in the schedule, the number of messages will be compared against the type that you specify.

Compare Options

Equal to	Variable is equal to
Less than	Variable is less than
Greater than	Variable is greater than
Less than/Equal to	Variable is less than or equal to
Greater than/Equal to	Variable is greater than or equal to
Not Equal to	Variable is not equal to
Changes Value	This condition will be true if the value changes since the last schedule pass.
Increases in Value	This condition will be true if the value has increased since the last schedule pass

Decreases in Value This condition will be true if the value has decreased since the last schedule pass

Bits 0-7 Set These conditions check to determine if the specified bit is set (has a value of one). Variables/Analog Inputs/HVAC values are stored as 8-bit numbers ranging from 0 to 255. Bit 0 is the least significant bit (LSB) and bit 7 is the most significant bit (MSB). Here are some examples:

If the variable = 0(decimal) (00000000b), no bits are set.

If the variable = 8(decimal) (00001000b), only bit 3 is set.

If the variable = 6(decimal) (00000110b), bits 1, and 2 are set.

If the variable = 192(decimal) (11000000b), bits 7 and 6 are set.

Bits 0-7 Not Set These conditions check to determine if the specified bit is NOT set (has a value of zero). Variables /Analog Inputs/HVAC values are stored as 8-bit numbers ranging from 0 to 255. Bit 0 is the least significant bit (LSB) and bit 7 is the most significant bit (MSB).

Compare Against

Value If selected, the Variable highlighted in the listbox will be compared against a value that can range from 0 to 255 (see picture above).

Analog Input If selected, the Variable highlighted in the listbox will be compared against an Analog Input shown in the listbox to the right.

Variable If selected, the Variable highlighted in the listbox will be compared against a Variable picked from the listbox to the right.

HVAC If selected, the Variable highlighted in the listbox will be compared against an HVAC value shown in the listbox to the right.

IF - LCD DigitPad

What is it When the Digitpad menu item button is pressed, the display switches to the Digitpad menu. The Digitpad menu contains pre-labeled buttons similar to a telephone keypad. While a DigitPad button is pressed, the corresponding menu line inverts to confirm the button press.

How Used Programming any single button press or sequence of button presses to perform an action requires an event in the Event Manager schedule using the IF - LCD DIGITPAD condition.

The DigitPad can serve as a security keypad with multiple access codes to arm and disarm a connected security panel. This requires an "armed" output from the security panel connected to one of the controllers digital inputs and one of its relays (COM and N.O. terminals) connected to a security panel zone programmed for "KEYSWITCH" operation. Example:

Example 12.26. EVENT: Security Access Code

```
If
LCD Seq:'1 2 3 4 ' Received within 4 seconds
Then
(RELAY:Security) ON
DELAY 0:00:01
(RELAY:Security) OFF
DELAY 0:00:02
If
(DI:Armed) is OFF
Then
LCD: Red LED OFF [KP:ALL]
Else
```

*LCD: Red LED Blink Slow [KP:ALL]
Nest End
End*

IF – Security

What is it The following security system conditions can be checked in an If-Then statement anywhere in your schedule.

How Used At the start of every schedule pass, the controller will process the information the security panel has sent. Any changes to partitions or zones will cause an internal “transition” state to be set for that pass through the schedule, the “transition” state will be cleared at the end of the schedule pass.

Transition Activated By selecting the “Transition Activated” checkbox, the IF condition will be TRUE when the condition **goes** active, as opposed to when the condition **is** active. This is best explained in an example:

Example 12.27. EVENT: Partition Armed

```
If
  Partition ARMED[Partion 1] TRANSITION
Then
  LCD: Red LED ON [KP:ALL]
End
```

In this example the LCD Keypads Red LED will be turned ON at the time the security panel gets armed.

Example 12.28. Event: Security Lights

```
EVENT: Security Lights
If
  Partition ARMED[Partion 1]
  and Sunset SMTWTFS -Security Mode-
Then
  X10: F-1 Front Porch Lt ON
End
```

In this example the Front Porch light will turn ON if the security panel IS armed (as opposed to GOES armed) and the time is Sunset. Note that if “Transition Activated” was used the Event would trigger only if the security panel became armed at the same time as Sunset.

Compare Options

Partition ARMED & in Home Mode

This condition is true if the specified partition is currently armed in the Home (Stay) mode. It will be false if armed in the Away mode or disarmed.

Partition ARMED

This condition is true if the specified partition is currently ARMED.

Partition Not Armed

This condition is true if the specified partition is currently disarmed.

Partition is READY

This condition is true if the specified partition is currently ready to arm.

Partition is Not READY

This condition is true if the specified partition is currently not ready to arm.

Partition has alarm condition

This condition is true if the specified partition currently has an alarm condition.

Partition has no alarm condition

This condition is true if the specified partition currently does not have an alarm condition.

Partition chime mode is ON

This condition is true if the specified partition's chime mode is currently on.

Partition chime mode is OFF

This condition is true if the specified partition's chime mode is currently off.

Partition Entry Delay Active

This condition is true if the specified partition has its Entry Delay in progress.

Partition Entry Delay Not Active

This condition is true if the specified partition's Entry Delay is not in progress.

Partition Exit Delay Active

This condition is true if the specified partition has its Exit Delay in progress.

Partition Exit Delay Not Active

This condition is true if the specified partition's Exit Delay is not in progress.

Zone is faulted

This condition is true if the specified zone is currently faulted.

Zone is not faulted

This condition is true if the specified zone is not currently faulted.

Zone is bypassed

This condition is true if the specified zone is currently bypassed.

Zone is not bypassed

This condition is true if the specified zone is not currently bypassed.

Zone is in trouble condition

This condition is true if the specified zone is currently in a "trouble" condition.

Zone is not in trouble condition

This condition is true if the specified zone is not currently in a "trouble" condition.

Zone has alarm in memory

This condition is true if the specified zone has an alarm stored in its memory (i.e., this zone is currently or was previously in an alarm condition).

Zone does not have alarm in memory

This condition is true if the specified zone does not have an alarm stored in its memory.

Any zone is faulted

This condition is true if any of the system zones are currently faulted.

Any zone is bypassed

This condition is true if any of the system zones are currently bypassed.

Any zone is in trouble condition

This condition is true if any of the system zones are currently in a "trouble" condition.

Any zone has an alarm in memory

This condition is true if any of the system zones currently have an alarm stored in memory.

Event Programming with THEN/ELSE Actions

An Event will execute the THEN Actions when the condition(s) in the IF section are TRUE, and the ELSE Actions when the condition(s) in the IF section are FALSE. THEN and ELSE actions can be any combination of X10 commands, IR commands, Telephone commands, Voice Responses, Audio Path, Relays (on/off), ASCII out, timers, flags, variables, logging a message and Then Macros.

To add a THEN or ELSE Action to an Event, place the highlight bar where you want to add the Action, in the THEN or ELSE section of the Event, and press the **[Add]** button in the Event Editor ToolBox.

A popup menu will appear allowing you to choose the type of THEN or ELSE action that you want. Select the type by moving the highlight bar and pressing [Return] or click with the mouse. A window will open and allow you to fill in the information needed.

Then/Else Action Menu

The following Then/Else Action selections are on the Then/Else action pop-up menu when you select **[Add]** button in the Edit Event ToolBox.

- **X10 Device**
- **Timer/Delay**
- **Flag**
- **Variable**
- **Message Log**
- **THEN Macro**
- **Comment**
- **IR**
- **ASCII**
- **Nested IF/THEN**
- **Relay Out**
- **HVAC**
- **Telephone**
- **Voice**
- **Audio Path**
- **VoiceMail**
- **LCD Keypad**
- **LED Keypad**
- **Security**

Then - X10 Device

<i>What is it</i>	These are the X10 Devices that have been defined and can be used in your schedule. You can also enter the HouseCode and UnitCode instead of using the X10 Device DataBase.
<i>How Used</i>	When used in the schedule, X10 Devices can be turned ON, OFF, Dimmed or Brightened. Also global commands such as All Lights On, All Lights OFF and All Units OFF can be sent.

<u>Menu Choices</u>	<u>Description</u>
Set Module to IDLE	Sets module to IDLE
Send Unit Code Only	Set mode to Unit Code Only
ON	Sets module to ON
OFF	Sets module to OFF
Brighten # steps	Brighten module # number of steps
Dim # steps	Dim module # number of steps
All Lights ON	Sends the All Lights ON command
All Lights OFF	Sends the All Lights OFF command
All Units OFF	Sends the All Units OFF command
Set to Level %	Sets the module to a specific level using standard X10 DIM/BRI commands
Preset to Level %	Sets the module to a specific level using PreSet X10 commands. Note the module must support the Preset Dim command.
Micro-Bright # steps	Micro Brighten the module # number of steps. This command is used with PCS style modules only.
Micro-Dim # steps	Micro Dim the module # number of steps. This command is used with PCS style modules only.
Status Request	Sends the Status Request command
Status is ON	Sends the Status=ON command
Status is OFF	Sends the Status=OFF command
Hail Request	Sends the Hail Request command
Hail Acknowledge	Sends the Hail Acknowledge command
Toggle Module State	Toggles the Modules State by sending an OFF command if the module is ON, an ON command if the module is OFF.
Refresh Module	Refresh the module by sending the current state of the module.
Enable Module	This command enables a module that was previously disabled. A module must be enabled before it will respond to any commands or transmit an X10 signal via the schedule.
Disable Module	A disabled module will not respond to any commands except for Enable Module. This command can be used as a quick way to prevent any other part of your schedule from controlling a module.
Enable X10 ON Trigger	Enables Fast Events based on the X10 ON Trigger. Fast Events Triggers are enabled by default. This command will enable a trigger if it has been disabled.
Disable X10 ON Trigger	Disables Fast Events based on the X10 ON Trigger. Fast Events Triggers are enabled by default. This command will disable a trigger if it has been enabled.

Enable X10 OFF Trigger	Enables Fast Events based on the X10 OFF Trigger. Fast Events Triggers are enabled by default. This command will enable a trigger if it has been disabled.
Disable X10 OFF Trigger	Disables Fast Events based on the X10 OFF Trigger. Fast Events Triggers are enabled by default. This command will disable a trigger if it has been enabled.
Set State to ON	This command sets the current state in the state table to ON, Level 11. It does not send any X10 signal over the power line.
Set State to OFF	This command sets the current state in the state table to OFF, Level 12. It does not send any X10 signal over the power line.
Set State to IDLE	This command sets the current state in the state table to IDLE. It leaves the level unchanged. It does not send any X10 signal over the power line.
Send ON Command Only	This command sends the X10 ON command.
Send OFF Command Only	This command sends the X10 OFF command.
Send BRI Command # times	This command sends the X10 BRI command ## number of times.
Send DIM Command # times	This command sends the X10 DIM command ## number of times.
Put current level into Variable	This command puts the X10 module's current light setting into the specified variable. If the light is ON, its level (0 to 10) will be put in the variable. If the light is OFF, the variable is set to 11. This command allows you to store the current level and later set the light back to it. See the following commands for more information on setting the light to the level contained in a variable.
Put 'Preset Dim' level into Variable	This command puts the received preset dim level (1 to 32) into the specified variable. This allows you to receive preset dim signals from devices that transmit them. Whenever the controller receives a preset dim signal immediately following a house/unit code signal, it stores the preset dim level for that house/unit code.
Set to level in Variable	This command reads the value of the specified variable and sets the X10 module to that level. If the variable value is 0 to 10, the light will be turned on at that level. If the variable value is 11, the light will go off. Remember that a light ON at level 0 is not the same as OFF.
Set to Preset Level in Variable	This command transmits a preset dim signal. The preset dim level (1 to 32) is taken from the specified variable. Thus, if the variable contains the value 12, the X10 signal "preset dim to level 12, 35%, " is transmitted.

Then - Timer/Delay

What is it These are the Timers that you have defined in the **Device DataBase**. Timers are countdown timers, meaning, once a Timer is loaded, it will decrement every second until it reaches zero (00:00:00), or is stopped by an Event. The maximum amount of time that can be loaded into a Timer is 18 hours, 12 minutes, 16 seconds (18:12:16).

How Used Timers can be used in an Event to provide 1 second resolution time events. The Timers can be stopped and started at any time as well as cleared.

Menu Choices Description

Stop	Stop the Timer from running. If the timer is already stopped or expired, this command has no effect.
Start	Start the Timer. If the timer is already running, this has no effect.
Clear	Clear the Timer, this will set the timer to 00:00:00.
Load	Load the Timer with the value specified. This will automatically start the Timer so no Start command is needed.

- Delay** Delay execution of this Event by the amount of time specified. When placed in an Event, the Delay statement will delay execution of only that Event, until the delay time has expired.
- Re-triggerable** If selected, the Delay will be re-triggerable. A re-triggerable Delay will be re-loaded automatically every time the If condition(s) become true.

Example 13.1. Delay Example 1.

```

EVENT Hallway Light
If
  (XSEQ: A-14 A-ON) Received within 4 seconds
Then
  (X:Hallway Light A-2) ON
  DELAY 0:05:00 -Re-triggerable
  (X:Hallway Light A-2) OFF
End

```

In this example, a motion sensor is setup to send the X10 'A-14 A-ON' command whenever motion is detected in the hallway. When this sequence is received, the Hallway Light will turn ON, wait 5 minutes and then turn OFF.

But what happens if somebody is in the hallway for more than 5 minutes or walks through with 1 second left? Normally, the Hallway Light will still turn off after 5 minutes. However, if you define the Delay as Re-triggerable, whenever the IF Condition is true again (X10 SEQ: A14 A-ON is this example) the Delay would be re-loaded with 5 minutes.

Example 13.2. Delay Example 2.

```

EVENT sprinklers
If
  Time = 4:00 AM SMTWTFS
Then
  (X:Sprinkler 1) ON
  DELAY 0:06:00
  (X:Sprinkler 1) OFF
  (X:Sprinkler 2) ON
  DELAY 0:04:00
  (X:Sprinkler 2) OFF
  (X:Sprinkler 3) ON
  DELAY 0:12:00
  (X:Sprinkler 3) OFF
End

```

In the example above, at 4:00 AM Sprinkler 1 will turn ON and the Event will Delay for 6 minutes. Sprinkler 1 will then turn OFF, and Sprinkler 2 will turn ON. After 4 minutes it will turn OFF and Sprinkler 3 will turn ON for 12 minutes and then turn OFF.

Note: Delays that are used in one Event will have no effect on any other Event.

Then – Flag

- What is it** Flags are used as variables or markers that have two states, Set or Cleared. Events can use Flags to communicate with each other.
- How Used** When used in the schedule, the controller can change the Flag state to Set, Clear or Idle.

Menu Choices	Description
Set	Set the Flag
Clear	Clear the Flag
IDLE	Set the Flag to IDLE

Example 13.3. It's Dark.

```

EVENT Set flag It's Dark
If
  After SunSet SMTWTFS
  or Before SunRise SMTWTFS
Then
  (F:It's Dark) SET
Else
  (F:It's Dark) CLEAR
End

```

In the above example, the flag 'It's Dark' will be set when it is dark, that is, after SunSet or before SunRise, and clear the flag when it is light outside.

Then - Variable

What is it Variables are 8 bit and can have a value that ranges from 0 to 255. This value can be loaded directly, loaded with an A/D Input value, loaded with another Variable, cleared, incremented or decrement. Two additional system variables are user_VAR (8 bit) and user_16VAR (16 bit). The user variables are used as exchange variables, various THEN Actions use these variables to store a value to later use by another THEN Action.

How Used Variables can be used to keep track of how many times something happens and can trigger other Events.

Menu Choices	Description
Load with Value	Load the Variable with the Value specified. Note that the maximum that can be loaded is 255 and the minimum 0.
Clear	Clear the Variable. This would be the same as loading the Variable with 0.
Increment	Increment the Variable by 1. If the value is already 255, this command will not do anything.
Decrement	Decrement the Variable by 1. If the value is already 0, this command will not do anything.
Load with A/D	Load the Variable with the A/D Input chosen in the rightmost listbox.
Load with Var2	Load the Variable with the value from another Variable.
Load Value	The value that will be loaded if the 'Load' option is chosen. Valid range for variables is 0-255.
Increment (roll-over at 255)	Increments (i.e. adds 1 to) variable . If the initial value is 255, it will roll over to zero.
Decrement (roll-under at 0)	Decrements (i.e. subtracts 1 to) variable . If the initial value is 0, it will roll over to 255.
Load with random number	Loads variable with a random number (range 0-255).
Load with user_VAR	Loads variable with user_VAR.

Load with HVAC	Loads variable with HVAC Temperature/Setpoint. Note this command can only work with the Bi-directional Thermostats.
variable = variable + ###	Add a value (###) to a variable.
variable = variable + var2	Add another variable.
variable = variable - ###	Subtract a value (###) from a variable.
variable = ### - variable	Subtract a variable from a value (###), and put it into the variable.
variable = variable - var2	Subtract a second variable from the first variable.
variable = variable * ###	Multiply a variable by a value (###). If the result is more than the variable maximum (255), it will be truncated to an 8-bit value.
variable = variable / ###	Divides a variable by a value (###).
Load with Sec	Loads seconds
Load with Min	Loads minutes
Load with Hour	Loads hours
Load with DOW	Loads Day of Week
Load with Date	Loads Date
Load with Month	Loads Month
Load with Year	Loads Year
Load user_VAR with another variable	Load the user_VAR with another variable.
Load var1 & var2 with user_16VAR	Loads two (8 bit) variables with the user_16VAR (16 bit). The Most Significant Byte (MSB) of user_16VAR is loaded into var1, the Least Significant Byte (LSB) is loaded into var2. For example, if user_16VAR contains 25,655 the command: load var1 & var2 with user_16VAR would give these results: var1 = 100 var2 = 55
Load user_16VAR with var1 & var2	Loads the user_16VAR(16 bit) with two (8 bit) variables . The Most Significant Byte (MSB) of user_16VAR is loaded by var1, the Least Significant Byte (LSB) is loaded by var2. For example, if var1 = 25 and var2 = 243 the command: load user_16VAR with var1 & var2 would give these results: user_16VAR = 6643 (The basic formula is: user_16VAR = (var1 x 256) + var2)
Load user_16VAR with var1 * var2	Loads the user_16VAR(16 bit) with the product of two (8 bit)variables multiplied together. For example, if var1 = 47 and var2 = 128 the command: load user_16VAR with var1 * var2 would give these results: user_16VAR = 6016
Load user_16VAR with var1 + var2	Loads the user_16VAR(16 bit) with the sum of two (8 bit)variables added together. For example, if var1 = 243 and var2 = 198 the command: load user_16VAR with var1 + var2 would give these results: user_16VAR = 441
Increment user_16VAR	Increments the user_16VAR, if the maximum value(65535) is reached, it will roll over to 0.
Decrement user_16VAR	Decrements the user_16VAR, if the minimum value(0) is reached, it will roll under to 65535.

Then - Message Log

<i>What is it</i>	Messages of up to 80 characters of text each can be saved to the Log. Analog Input and Variable values can be embedded into the text as well. The Log can hold 8000 characters of message data. Each Log entry has a 6 character overhead for time and date, so if you were logging a 10 character message, you could store 500 entries. $(8000/(10 \text{ [for message]} + 6 \text{ [for overhead]}) = 500)$.
<i>How Used</i>	The text in the Log statement will be saved in the Log and can be read out using the Read Log utility. A Wizard function is available to aid in embedding variables and Analog Inputs or Variables into the text string.

Example 13.4. Message Log.

```

EVENT: Log Output Example
If - Always
(F:Log Temp) is ON
Then
LOG: 'Temp is <Outside Temp> Degrees'
Delay 1:00:00
End

```

In this example, as long as the Flag 'Log Temp' is ON, the temperature will be stored in the Log at an hourly interval.

Then - THEN Macro

<i>What is it</i>	A THEN Macro is set of THEN Actions that have a name (like an Event with no IF conditions) and can be called multiple times in a schedule.
<i>How Used</i>	When used in the schedule, the controller will execute the statements in the THEN Macro. THEN Macros are useful when a group of Devices will be turned ON or OFF many times in a schedule. Defining these Devices as a Macro will simplify programming.

Example 13.5. THEN MACRO 'Day Lights Off'.

```

MACRO BEGIN
(X: Hallway Light A-7) OFF
(X: Bedroom Light A-15) OFF
(X: Kitchen Light A-4) OFF
(X: Bathroom Light A-3) OFF
End

```

Example 13.6. Using THEN MACRO.

```

EVENT Turn off Lights in daytime
If
Time = 9:00 AM .MTWTF.
Then
(THEN MACRO: Day Lights Off)
End

```

Then - Comment

<i>What is it</i>	A Comment can be a description or a note. It does not affect the way the Event works in any way.
<i>How Used</i>	When used in the schedule, a Comment can add some description of what the Event is doing. A Comment can be placed anywhere within the Event.

Then - IR

These are the IR Commands that are available for use in an Event (requires *IR-XP² InfraRed Xpander*).

For complete setup, programming and operational information, refer to the IR-XP² InfraRed Xpander instruction manual.

<i>What is it</i>	The IR Command will instruct the InfraRed Xpander to issue an IR command defined in the Define IR menu.
<i>How Used</i>	When used in a Schedule, the controller instructs the InfraRed Xpander to send the highlighted IR command out the selected Emitter Output(s), the number of times selected in the 'Play _ Times' box.

Menu Choices Description

IR Commands	This is the IR command that will be sent.
Emitter Outputs	This is the Emitter Output port(s) of the InfraRed Xpander the selected IR command will be sent out of.
Play ## Times	This is the number of times the IR command will be sent.

Then - ASCII Out

<i>What is it</i>	Up to 80 characters of ASCII text can be sent out the serial port to be used by other programs or products and converting ASCII input strings into the user_VAR variable. Analog Input and Variable values can be embedded into the text as well. ASCII Out can also trigger Wave files (.wav) and execute other Windows programs (.exe).
-------------------	---

<i>How Used</i>	The text in the ASCII Out statement will be sent out the serial port. Select the controller COM port ("Destination") that will send the ASCII data. Programs other than Event Manager can use this text as a monitor, to trigger another program on a PC, etc. ASCII Out text will show up in the MegaController.
-----------------	---

To include Analog Inputs or Variables into the ASCII string, place the Analog Input or Variable name between the < > characters similar to this: <name>. When the ASCII text is printed, the <name> will be replaced with the value of the Analog Input or Variable.

If you need more than 80 characters of text in a line, you can combine lines by putting the '\ ' character as the last character is the line (see example below).

Menu Choices Description

Output ASCII String	Send the ASCII string to the specified port.
----------------------------	--

(The following commands look at the specified character location(s) in a serial data string, converts it to a number, and loads it into the system variable user_VAR. After the value is put in user_VAR, you can use variable commands to move it to a variable and perform other operations on it)

Put value of received char # into user_VAR

Converts a single character into a number, which must be between 0 and 9.

Put value of received char ## into user_VAR

Converts two consecutive characters into a number, both of which must be between 0 and 99.

Put value of received char ### into user_VAR

Converts three consecutive characters into a number, all of which must be between 0 and 255.

Wizards are available to assist adding Time/Date, CID, variables, analog inputs, user_VAR, user_16VAR, binary value and Lutron HomeWorks commands.

Example 13.7. ASCII Out.

```
EVENT: ASCII Out Example 1
If
  (X:FrontDoor PIR H8) is ON
Then
  (V:Frnt Door ) Increment
  ASCII-Out: '<Frnt Door> people approached door' [COM 2]
End
```

```
EVENT: ASCII Out Example 2
If
  ASCII-In: 'Temp'
Then
  ASCII-Out: 'Temperature is <Outside Temp> \'
  ASCII-Out: 'degrees'
End
```

In the first example, every time the FrontDoor motion detector (PIR) is triggered the 'Frnt Door' Variable is incremented and the ASCII Out string is sent out the serial port. In this example, if the 'Frnt Door' Variable is incremented to 12, the ASCII Out string would be:

"12 people approached door"

In the second example, the Analog Input "Outside Temp" is connected to a temperature sensor and the current temperature is 77 degrees. When the ASCII-In "Temp" is received, the ASCII-Out string sent out the serial port is:

"Temperature is 77 degrees "

Note the use of the '\' character at the end of the first ASCII-Out string and how it kept the two lines together. If the '\' character was not used, the string would look like this:

"Temperature is 77"

"degrees"

Example 13.8 ASCII Variable setting example 1.

If the received data string is: "234"

The following command sets user_VAR equal to 2:

Put value of received char #1 into user_VAR

The following command sets user_VAR equal to 2:	Put value Of received char #2 into user_VAR
The following command sets user_VAR equal to 23:	Put value Of received chars #1-2 into user_VAR
The following command sets user_VAR equal to 234:	Put value Of received chars #1-3 into user_VAR

Example 13.9. ASCII Variable setting example 2.

If the received data string is: "Wind Speed is 15"

The following command sets user_VAR equal to 15: Put value Of received chars #15-16 into user_VAR

Wave File Support

To play a wave file first you must have the capability to play wave files through a sound card. Use the software that came with the sound card to create or edit wave files for WinEVM, or you can use the Windows Sound Recorder (a standard Microsoft Window's accessory) with your sound card to record your wave files. The wave files must be located in the WinEVM directory/folder or a directory/folder listed in your autoexec.bat path.

To get a WinEVM event to play a wave file, simply add the **@@filename.wav** character string as your ASCII Output, and WinEVM will use the Windows built in MCI features to send the wave file to the sound card (see example below). The wave file can be any length, playing will not affect any functions, although the MegaController may be temporarily affected.

Note: For the wave file to play, WinEVM must be running with the MegaController active. The MegaController captures the ASCII Out text, and when it detects the special "@@" string, it sends the wave file information to the sound card to play.

WinExec Support

To get a WinEVM event to execute a Windows program, simply add the **&& program.exe** character string as your ASCII Output, and WinEVM will execute the program (see example below).

Note: For the WinExec feature to work, WinEVM must be running with the MegaController active. The MegaController captures the ASCII Out text, and when it detects the special "&&" string, it triggers the program.

Example 13.10. Play a ".Wav" File and execute a Windows program.

```

EVENT: Wave & WinExec Example
If
  (X:FrontDoor PIR H8) is ON
Then
  (V:Frnt Door ) Increment
  ASCII-Out: '<Frnt Door> people approached Door'
  ASCII Out: '@@hello.wav'
  ASCII Out: '&&notepad.exe'
End

```

Then - Nested IF/THEN

What is it A Nested IF/THEN is an Event within an Event. It can be an AND or OR as well as IF/THEN or IF/THEN/ELSE. **The maximum levels of nesting is 3.**

How Used Nesting can be used to simplify a complex set of criteria for doing some action.

Example 4.45. Nesting example:

```
EVENT: Nesting Example1
If
(XSEQ: M-1 M-ON) received with 3 seconds
Then
  If
    (X:Drapes A-13) is ON
  Then
    (X:Drapes A-13) OFF
  End
  If
    (X:TV B-1) is OFF
  Then
    (X:TV B-1) ON
  End
End
```

In the above example, if the X10 sequence M-1 M-ON is received, it will then test to see if the Drapes (A-13) are open, if they are, the controller will close them, it then tests if the TV (B-1) is off, if it is, the controller will turn it on.

~~Then~~ Relay Output

How Used When used in a schedule, the controller will turn the selected Relay ON or OFF.

<u>Menu Choices</u>	<u>Description</u>
ON	If selected, the Relay Output highlighted in the listbox will be turned ON.
OFF	If selected, the Relay Output highlighted in the listbox will be turned OFF.
PULSE	Pulse the relay on for x number of seconds.

Then – HVAC

What is it Thermostat's Setpoint, Modes, Fan and Setback Temperatures can be controlled through a schedule. The Thermostat must have been previously defined in Define | HVAC.

How Used Select the Thermostat and the command to be sent.

<u>Menu Choices</u>	<u>Description</u>
Set (Setpoint) Temperature	Adjust the Thermostat's SetPoint.
OFF	Set the Thermostat's operating mode to OFF.
HEAT	Set the Thermostat's operating mode to HEAT.
COOL	Set the Thermostat's operating mode to COOL.
AUTO	Set the Thermostat's operating mode to AUTO.
Increment Setpoint	Increment the Thermostat's Setpoint by 1 degree.
Decrement Setpoint	Decrement the Thermostat's Setpoint by 1 degree.
Setback ON	Enable the SetBack mode and the SetBack offset.
Setback OFF	Turn the SetBack mode OFF.

FAN ON	Turn the FAN ON.
FAN OFF	Turn the FAN OFF.
Load SetPoint with user_VAR	Loads the selected Thermostat's SetPoint with user_VAR. This command is useful to set the Setpoint via TouchTone input.

Example 13.11. Change HVAC SetPoint via Phone.

```

EVENT: Change Temp Setpoint
If
  Telephone Seq: '^4822' Received within 7 seconds
  " Go OFFHook, dial HVAC (4822) "
Then
  Voice:TEMPERAT SET Thermo Setpoint [CO,ICM]
  TouchTone to user_VAR
End

EVENT: Temp Setpoint Done
If
  TouchTone to user_VAR complete
Then
  (V:Temp Setpoint) load with user_VAR
  /-If
  / (V:Temp Setpoint) != 255
  /Then
  / (HVAC:Thermo) Change Setpoint to value in user_VAR
  / "allow enough time for X10 codes"
  / DELAY 0:00:03
  / "reply with new Setpoint"
  / Voice:TEMPERAT SET TO Thermo Setpoint [CO,ICM]
  /Else
  / Voice:INVALID TEMPERAT [CO,ICM]
  /-End
End

```

Then - Telephone

The **Telephone** selection lets you program automatic TouchTone dialing, off-hook, on-hook, hold, pause and hookflash signals. This can be used in conjunction with telephone company services such as paging, caller ID, three-way calling and call forwarding to provide increased communications capabilities.

Telephone Out

The Telephone Out Tab page allows you to create a sequence of TouchTone digits, ON/OFF hook commands or TouchTone CallerID or user_VAR.

Note: Off-Hook is represented by “^”, On-Hook by “+”, Pause by “,” and Hookflash by “!”.

Digits 0-9	Sends TouchTone digits to the C.O. Line output
ON/OFF Hook	Sends the command for the C.O. Line to go ONHook or OFFHook.
HookFlash	Sends the command for the C.O. Line to HookFlash. The HookFlash time is defined in the Define Telephone field.
Pause	Pauses an amount of time as defined in the Define Telephone field.
user_VAR	Converts the value of user_VAR to TouchTone Digits and sends to the C.O. Line.
Caller ID	The last Caller ID message can be used in the Telephone Output field. By placing the upper case letter 'C' in the THEN TELEPHONE OUT field, it will be replace with the contents of the Caller ID buffer. A header (prefix) onto the CID number as shown below:

CID Header: 001 valid number
 002 private Number
 003 unknown Number

Examples : 001-858-486-8787 (valid number)
 002-000-000-0000 (private Number)
 003-000-000-0000 (unknown number)

Telephone Control

Go OFFHook Takes the C.O. Line OFFHook.
Go ONHook Puts the C.O. Line ONHook.
HookFlash Sends the command for the C.O. Line to HookFlash. The HookFlash time is defined in the Define | Telephone field.
Go ON Hold Puts the C.O. Line in a Hold state.
Release Hold Releases the Hold state.
Remote Access Force the Remote Access mode for the give user.
Enable TouchTone Access Enable the built-in TouchTone to X10 system.
Disable TouchTone Access Disable the built-in TouchTone to X10 system.
Clear TouchTone Buffer Clears any TouchTone digits that are in the TouchTone input buffer.
Phone to ICM Connects the Phone jack to the Intercom (ICM) jack.
Phone to C.O. Connects the Phone jack to the C.O. (Line) jack.

Load user_VAR with TouchTone [SYNC]

Loads user_VAR with the next 1-3 TouchTone digits followed by the # digit. When the conversion is done, the IF Condition 'TouchTone to user_VAR complete' will be true and user_VAR will contain the number. If the conversion does not complete normally, the user_VAR will contain 255. The [SYNC] option eliminates the need for a separate event to look for the IF Condition "TouchTone to user_VAR complete".

Selecting the SYNC option will pause the entire schedule until the conversion is done.

A conversion that does not complete normally is caused by one of the following:

1. More than 3 TouchTone digits are entered.
2. A 10 second timeout occurs
3. Converted value is greater than 255

Example 13.12. Change Setpoint.

```

EXAMPLE
THEN Macro: Change Setpoint
MACRO BEGIN
  Voice: ENTER NEW TEMPERAT [Spkr,CO,ICM]
  TouchTone to user_VAR SYNC
  (V:Temp Setpoint) load with user_VAR
  /-If
  |(V:Temp Setpoint) < 80
  |(V:Temp Setpoint) > 60
  /Then
  | (HVAC:Thermo) Change Setpoint to value in user_VAR
  | Voice:BBBEEP [CO,ICM]
  | DELAY 0:00:04
  | Voice:NEW SET TEMPERAT IS Thermo Setpoint DEGREES [CO,ICM]
  /Else
  
```

```
| Voice:INVALID TEMPERAT [CO,ICM]
|- Nest End
MACRO END
```

Load TimeLabel with TouchTone [SYNC]

Loads a TimeLabel with the next 2 - 4 TouchTone digits followed by the * digit for AM or the # digit for PM. When the conversion is done, the IF Condition 'TouchTone to TimeLabel complete' will be true and the TimeLabel will contain the new Time. If the conversion does not complete normally, the IF Condition 'TouchTone to TimeLabel complete' will NOT be set and the TimeLabel will not have been changed. The [SYNC] option eliminates the need for a separate event to look for the IF Condition "TouchTone to TimeLabel complete".

Selecting the SYNC option will pause the entire schedule until the conversion is done.

A conversion that does not complete normally is caused by one of the following:

1. More than 4 TouchTone digits are entered
2. A 10 second timeout occurs
3. Converted value is not a valid time

Example 13.13. Change a wake up time.

```
EVENT: Change WakeUp Time
If
  Telephone Seq: '^9253' Received within 6 seconds
  " (Enter W-A-K-E on telephone) "
Then
  " Say current wakeup time "
  Voice:WAKE_UP <Wake Up Time> [CO,ICM]
  TouchTone to Time Label:(TL:Wake Up Time)
End

EVENT: Wakeup time Converted
If
  TouchTone to TimeLabel complete
Then
  " Say new wakeup time "
  Voice:WAKE_UP TIME <Wake Up Time> [CO,ICM]
End
```

Example 13.14. Reporting Temperature to a Page.

In the following example, if the inside temperature exceeds 80 degrees, the controller dials a pager (goes off-hook and dials 123-4567), waits 6 seconds for the paging service to answer (3 commas), then dials the temperature (V) followed by the pound sign (#) to complete the page and hangs up (+). The temperature will then appear on the pocket pager display!

```
EVENT: CALL JOHN'S PAGER
If:
  (Analog In: TEMP) > 80 degrees
Then:
  Load user_VAR with (Analog :TEMP)
  Telephone Out: '^ 123-4567 ,,, V # +'
End
```

Then - Voice Functions

Adding A Voice Response To An Event

To add a Voice Output to an event:

- 1) Click on the **THEN** line of the event then click on **ADD**.
- 2) Click on **VOICE** then click on **VOICE RESPONSE**.
- 3) Click the desired VOICE RESPONSE TYPE (Preset, User-Defined, Analog, Variable, Wave file or Special).
- 4) double-click on the desired Voice Response in the list. Each selection will appear in the SELECTIONS box.
- To **PREVIEW** a response, click on the desired Voice Response then click PREVIEW.
- 5) To form sentences, repeat steps 3 and 4. Responses will play in the order they appear in the SELECTIONS box.
- To **DELETE** a Voice Response from the Selection box, click once on the response and then click DELETE.
- To **REPLACE** a Voice Response with a different one from the list, click once to highlight the response in the Selection Box then click on the desired Voice Response in the list, then click REPLACE.
- 6) Select **OUTPUT(s)** (SPEAKER, LINE LEVEL, C.O. LINE, INTERCOM).
- 7) Select the desired **VOLUME** level (0 = lowest, 12 = highest).
- 8) Select **SYNCHRONOUS** if you want the Voice Response to complete playing before executing the next line of the event (except Wave files, which are asynchronous only).
- 9) Click OK. A "VOICE" line will appear in the THEN section of the event.

Example 13.15. Report Temperature with Voice.

```
EVENT: REPORT TEMPERATURE
If:
  (A-1 A-ON) is Received within 3 seconds
Then:
  (VOICE: "The Temperature Is <temp> Degrees") [Speaker]
End
```

Then - Audio Path

Connecting Voice Inputs To Voice Outputs

In some cases it may be desirable to route audio from an input source (C.O. Line, Intercom or Line-Level Input) to the Speaker Output, Line-Level Output, C.O. Line or Intercom. For example, connecting the C.O. Line to the Line-Level Output will allow remote voice paging through a PA amplifier. A music source connected to the Line-Level Input can be routed to the Speaker Output for background music and to the C.O. Line for "Music-On-Hold." A pre-amplified microphone connected to the Line-Level Input can be routed to the C.O. Line for remote audio monitoring.

To connect (or disconnect) an input source to an output:

- 1) Click on the **THEN** line of the event then click on **ADD**.
- 2) Click **AUDIO PATH**.
- 3) Select the **INPUT SOURCE** (C.O. Line, Intercom or Line-Level Input).
- 4) Select the **OUTPUT** (Speaker Output, Line-Level Output, C.O. Line or Intercom).
- 5) Select **CONNECT** or **DISCONNECT**.
- 4) Click **OK**.

Note: Once an input is connected to an output, it will remain connected until instructed to disconnect.

Example 13.16. REMOTE VOICE PAGING.

In the following example, the Line-Level Output is connected to a PA amplifier with speakers throughout the premises. User 1 calls home remotely, then enters a Remote Access Code followed by *72 (*PA) to allow live voice paging through his house PA system. The voice prompt "Paging Access ON" is sent to the C.O. Line to signal User 1 that his/her voice is about to be broadcast throughout the house. The Audio Path between the C.O. Line and Line-Level Output is then connected for 15 seconds during which User 1 speaks his/her announcement. The Audio Path between the C.O. Line and Line-Level Output is then disconnected and the voice prompt "Paging Access OFF" is then sent to the C.O. Line to signal User 1.

EVENT: REMOTE VOICE PAGING

If:

*(Remote Access - User 1)
and (Telephone: *72) is Received within 3 seconds*

Then:

*(VOICE: "Paging Access ON") [C.O. Line]
(AUDIO PATH: Connect C.O. Line to Line Level Output)
Delay 0:00:15
(AUDIO PATH: Disconnect C.O. Line to Line Level Output)
(VOICE: "Paging Access OFF") [C.O. Line]*

End

Example 13.17. REMOTE AUDIO MONITORING (LISTEN IN).

In the following example, a hidden microphone is connected to a preamplifier, the output of which is connected to the controller's Line-Level Input. User 1 calls home, then enters a Remote Access Code followed by *54 to remotely monitor sound in the house for 30 seconds.

EVENT: REMOTE LISTEN IN

If:

*Telephone - Remote User 1
and (Telephone: *54) is Received within 3 seconds*

Then:

*(AUDIO PATH: Connect Line Level Input to C.O. Line)
Delay 0:00:30 (Retriggerable)
(AUDIO PATH: Disconnect Line Level Input to C.O. Line)*

End

Recording A Voice Response In An Event

In some cases it may be desirable to record audio from an input source (C.O. Line, Intercom or Line-Level Input) when triggered by an event such as recording messages from callers, leaving messages for callers identified by CallerID or memos for family members, etc.

To program an event to RECORD a Voice Response:

- 1) Click on the **THEN** line of the event then click on **ADD**.
- 2) Click on **VOICE** then click on **USER VOICE RECORD**.
- 3) Select a line in the **USER DEFINED RESPONSE** list.
- 4) Type the name of the User-Defined Response to be recorded.
- 5) Select the **RECORD SOURCE** (Intercom, C.O. Line, Line-Level-Input).
- 6) Select the maximum **RECORD TIME** allowed for the voice response.
- 7) Click **OK**.

NOTE: When using the USER VOICE RECORD feature, the user will hear a beep prompt to indicate when to begin speaking. Pressing any TouchTone key will stop the recording and automatically playback the recorded message for review. If a TouchTone key is not pressed, the recording will stop automatically when the RECORD TIME has elapsed.

Example 13.18. Recording messages from identified callers.

In the following example, the controller answers calls from a specific caller (identified by CallerID) and prompts them to press 1 to leave a message.

```
EVENT: RECORD JOHN
  If
    CallerID: 212-555-1212
  Then
    If
      Voice: "Hi John, press 1 to leave a message" [C.O. Line]
      Telephone Seq: '1' Received within 15 seconds
    Then
      Record: 'John's Message' from CO Line for 20 seconds
    End
  End
End
```

Example 13.19. Recording (or changing) messages remotely by phone.

With the following events, User1 can call home, enter his/her Remote Access Code, then press *-R-E-C (*732) to record (or change) a message that will playback through speakers at home as soon as someone arrives and disarms the security system such as "Call me at the office as soon as you get home."

```
EVENT: ARRIVE MESSAGE RECORD
  If
    Telephone: Remote User1
    and Telephone Seq: '*732' Received within 10 seconds
  Then
    Record: Arrived Message from CO Line for 20 seconds
  End
```

```
EVENT: ARRIVE MESSAGE PLAYBACK
  If
    (DI:Armed) Goes OFF
  Then
    Voice: Arrived Message [SPEAKER]
  End
```

Then – VoiceMail

All VoiceMail functions can be controlled through the schedule allowing very custom VoiceMail systems.

<u>Menu Choices</u>	<u>Description</u>
Say Number of Messages	Announce the number of messages in a particular Mailbox.
Play First Message	Start playing the first message in the Mailbox.
Next Message (skip)	Skip to the next message in the mailbox.
Delete Message	Delete the current message. Note that the message must have been played before it can be deleted.
Replay Message	Replay the current message. Note that the message must have been played before it can be replayed.
Play Caller ID	Announce the Caller ID number for the current message. Each message is tagged with the Caller ID number. Note that the message must have been played before using this command.
Stop Message	Stop the current message from playing.
Play All Messages	Play All Messages in a mailbox.
Play All NEW Messages	Play All NEW Messages in a mailbox. Once a NEW message has been played, it is changed to an OLD message.
Backup 5 Seconds	Re-winds the current message being played by 5 seconds.
Forward 5 Seconds	Advance the current message being played by 5 seconds.
Force VoiceMail	Force a VoiceMail session. This will place the VoiceMail system in a state as if the controller answered the incoming call.
Select Greeting	Change the Greeting for the selected Mailbox.
Announce Only On	Enable Announce Only feature. If Enabled, the system will answer the incoming call but not allow a message to be left.
Announce Only Off	Disable Announce Only feature.
Answer on Ring #	Change the ring count to answer on. Looking at the number of messages in particular mailboxes and changing the ring count can make a Toll-Saver feature.
Incoming Call Monitor ON	Enable the Incoming Call Monitor. If Enabled, the Greeting as well as the message being left will be heard.
Incoming Call Monitor Off	Disable the Incoming Call Monitor.
Load user_VAR with # of NEW Messages	Loads user_VAR with the number of NEW Messages in a particular Mailbox.
Load user_VAR with # of OLD Messages	Loads user_VAR with the number of OLD Messages in a particular Mailbox.

Then - LCD Keypad

In addition to all the menu functions that can be downloaded and stored in the LCD Keypad, a variety of scheduled actions can be incorporated into the Event Manager schedule to interact with the keypad using the THEN - LCD KEYPAD function. These include **LED Functions** that control the three LEDs, **Menu Screen Functions** that affect individual menus or menu lines and **Keypad Functions** that affect the entire keypad.

LED Functions

- **Red LED ON** - turns the red LED on steady.
- **Red LED OFF** - turns the red LED off.
- **Red LED Blink Slow** - blinks the red LED on and off 2 times per second.
- **Red LED Blink Fast** - blinks the red LED on and off 4 times per second.
- **Green LED ON** - turns the green LED on steady.
- **Green LED OFF** - turns the green LED off.
- **Green LED Blink Slow** - blinks the green LED on and off 2 times per second.
- **Green LED Blink Fast** - blinks the green LED on and off 4 times per second.
- **Yellow LED ON** - turns the yellow LED on steady.
- **Yellow LED OFF** - turns the yellow LED off.
- **Yellow LED Blink Slow** - blinks the yellow LED on and off 2 times per second.
- **Yellow LED Blink Fast** - blinks the yellow LED on and off 4 times per second.

Menu Screen Functions

- **Update LCD Variable** - sends current value of the specified variable to all keypads.
- **Clear Menu Screen** - clears the LCD screen display.
- **GoTo Menu Screen** - switches to a specific menu.
- **Write Text** - sends temporary text to a menu line on a specific or all keypads.
- **Change Text** - changes text on a specific menu line of a specific menu.
- **Invert Text** - reverses the background and text color of a specific menu line.
- **Un-Invert Text** - returns the background and text color of a specific menu line to normal.

Keypad Functions

- **Backlight ON** - turns on backlight.
- **Backlight OFF** - turns off backlight.
- **Backlight Timeout** - sets backlight timeout (seconds).
- **Default Menu** - sets the default menu.
- **Default Menu Timeout** - sets the default menu timeout (seconds).
- **Keypad ON Line** - turns on communication between keypad buttons and the controller.
- **Keypad OFF Line** - turns off communication between keypad buttons and the controller.

Then - LED Keypad

In addition to built in functions that can be downloaded and stored in the LED Keypad, LED control actions can be incorporated into the Event Manager schedule.

LED Functions

- **Red LED ON** - turns the red LED on steady.
- **Red LED OFF** - turns the red LED off.
- **Red LED Blink Slow** - blinks the red LED on and off 2 times per second.

Then – Security

The following security system commands can be used anywhere in your schedule.

Select Partitions:

Select partitions 1- 8. You can select any or all partitions for most options.

Security Options:

ARM partition in Home Mode

This command arms the partition(s) in the Home (Stay) mode. There will be separate check boxes on the screen for each partition in your system. You can select any or all of the partitions to arm.

ARM partition

This command arms the partition(s) specified. There will be separate check boxes on the screen for each partition in your system. You can select any or all of the partitions to arm.

Disarm partition

This command disarms the partition(s) specified. There will be separate check boxes on the screen for each partition in your system. You can select any or all of the partitions to disarm. If an alarm is going off, this command will silence it.

Turn partitions chime mode ON

This command turns on the chime mode for the partition(s) specified. There will be separate check boxes on the screen for each partition in your system. You can select any or all of the partitions to turn on.

Turn partitions chime mode OFF

This command turns off the chime mode for the partition(s) specified. There will be separate check boxes on the screen for each partition in your system. You can select any or all of the partitions to turn off.

Toggle partitions instant mode

This command toggles the "instant" mode for the partition(s) specified. There will be separate check boxes on the screen for each partition in your system. You can select any or all of the partitions to control. If the partition instant mode is currently off, it will turn on. If it is currently on, it will turn off.

Sound partitions Fire Panic

This command sounds the "fire panic" alarm for the partition(s) specified. There will be separate check boxes on the screen for each partition in your system. You can select any or all of the partitions to sound.

Sound partitions Medical Panic

This command sounds the "medical panic" alarm for the partition(s) specified. There will be separate check boxes on the screen for each partition in your system. You can select any or all of the partitions to sound.

Sound partitions Police Panic

This command sounds the "police panic" alarm for the partition(s) specified. There will be separate check boxes on the screen for each partition in your system. You can select any or all of the partitions to sound.

Bypass zone

This command bypasses a particular zone.

Un-Bypass zone

This command un-bypasses a particular zone.

Send X10 ON Command Sends X10 ON command for House/Unit Code selected.

Send X10 OFF Command

Sends X10 OFF command for House/Unit Code selected.

Some of the controllers have a built-in battery backup that allows it to retain its memory in case your house has a power failure, or you decide to move it to another location. The controller can also detect when you have had a power failure and let you act on it.

When the power goes off in your home, most of the X10 type equipment will go off, when power comes back on, the controller may think these devices are still on, creating an out of sync problem. Another scenario is if during the time the power was out, your schedule was supposed to turn a device on, since power was not on at the time the device was to turn on, it never did.

For example, assume you had a light scheduled to turn on at 6:15:

From 6:00 to 6:30, there was a power failure:

When the power comes back on, the light will be off because it never got the ON command at 6:15.

Power Fail Catch-up.

The controller knows that the power failed and will do the following:

- Play catch-up to the current time and force any X10 device that has it's 'Play Catch-up' flag set, to the state it would have been in had the power not gone out.
- Set the 'Power-Fail' variable for use in the Schedule.
- The Catch-up time will depend on how long the power was out and how large your schedule is.

Controller Actions

During Power Fail Catch-up, the controller's X10 yellow and green LED's will flash steadily. After catching up, both LED's will be on solid.

- Device DataBase** - The area where your Devices are created and stored.
- Editor Workspace** - Area where schedules are edited.
- ELSE Section** - The area in an Event between the 'Else' and 'End' keywords.
- Event** - An If section followed by a Then section. If the 'If' section is true, the 'Then' section is executed.
- Flag** - A variable that has two states, Set or Clear.
- Highlight Bar** - The black bar seen in a schedule showing the current position.
- IF Conditions** - Used by an Event to determine whether to do the 'Then' or 'Else' sections of an Event.
- IF Macro** - A series of 'If Conditions'.
- IF Section** - The area in an Event between the 'If' and 'Then' keywords.
- Initial State** - The initial state of a Device in the **Device DataBase**.
- Message** - A text message that the controller can log.
- Message Log** - The storage area for messages.
- PSC05** - X10Pro two-way Power Line Interface (PLI) module (same as TW523).
- Refresh Interval** - The period of time between refresh cycles.
- Schedule** - A series of Events that control your home.
- SunRise/SunSet** - The times that the sun rises in the morning and sets in the evening.
- THEN Actions** - What will execute when the conditions in the 'If' section are true.
- THEN Macro** - A series of 'Then' actions.
- THEN Section** - The area in an Event between the 'Then' and 'Else' or 'End' keywords.
- TimeLabels** - A time that has a label associated with it.
- Timer** - Used to provide time based Events.
- TW523** - X10 two-way Power Line Interface (PLI) module (same as PSC05).
- Variable** - Used by schedule events for counting.
- X10 Device State** - The state of an X10 device (ON/OFF) at the time the controller is looking at it.
- X10 Sequence** - Up to 6 X10 commands within a specified time window.

Appendix A – Lat/Long by City

City	State	Latitude	Longitude
Birmingham	Alabama	33 N	86 W
Dothan	Alabama	31 N	85 W
Huntsville	Alabama	34 N	86 W
Mobile	Alabama	30 N	88 W
Montgomery	Alabama	32 N	86 W
Adak Island	Alaska	51 N	176 W
Anchorage	Alaska	61 N	149 W
Fairbanks	Alaska	64 N	147 W
Juneau	Alaska	58 N	134 W
Nome	Alaska	64 N	165 W
Point Barrow	Alaska	71 N	156 W
Flagstaff	Arizona	35 N	111 W
Phoenix	Arizona	33 N	112 W
Tucson	Arizona	32 N	110 W
Yuma	Arizona	32 N	114 W
Fort Smith	Arkansas	35 N	94 W
Jonesboro	Arkansas	35 N	90 W
Little Rock	Arkansas	34 N	92 W
Texarkana	Arkansas	33 N	94 W
Bakersfield	California	35 N	119 W
Bishop	California	37 N	118 W
Eureka	California	40 N	124 W
Fresno	California	36 N	119 W
Long Beach	California	33 N	118 W
Los Angeles	California	34 N	118 W
Needles	California	34 N	114 W
Sacramento	California	38 N	121 W
San Bernardino	California	34 N	117 W
San Diego	California	32 N	117 W
San Francisco	California	37 N	122 W
San Jose	California	37 N	121 W
Santa Ana	California	33 N	117 W
Santa Barbara	California	34 N	119 W
Colorado Springs	Colorado	38 N	104 W
Denver	Colorado	39 N	104 W
Durango	Colorado	37 N	107 W
Grand Junction	Colorado	39 N	108 W
Greeley	Colorado	40 N	104 W
Pueblo	Colorado	38 N	104 W
Hartford	Connecticut	41 N	72 W
New Haven	Connecticut	41 N	72 W
New London	Connecticut	41 N	7 W
Stamford	Connecticut	41 N	73 W
Storrs	Connecticut	41 N	72 W
Washington	D.C	38 N	77 W
Dover	Delaware	39 N	75 W
Wilmington	Delaware	39 N	75 W
Copenhagen	Denmark	55 N	12 E
Ringkobing	Denmark	56 N	8 E
Gainesville	Florida	29 N	82 W
Jacksonville	Florida	30 N	81 W
Key West	Florida	24 N	81 W
Miami	Florida	25 N	80 W
Orlando	Florida	28 N	81 W
Pensacola	Florida	30 N	87 W
Tallahassee	Florida	30 N	84 W
Tampa	Florida	27 N	82 W
Albany	Georgia	31 N	84 W
Athens	Georgia	33 N	83 W
Atlanta	Georgia	33 N	84 W
Augusta	Georgia	33 N	81 W
Brunswick	Georgia	3 N	81 W
Columbus	Georgia	32 N	84 W

Macon	Georgia	32 N	83 W
Hilo	Hawaii	19 N	155 W
Honolulu	Hawaii	21 N	157 W
Kailua	Hawaii	19 N	156 W
Lihue	Hawaii	21 N	159 W
Wailuku	Hawaii	20 N	156 W

City	State	Latitude	Longitude
Boise	Idaho	43 N	116 W
Lewiston	Idaho	46 N	117 W
Pocatello	Idaho	42 N	112 W
Twin Falls	Idaho	42 N	114 W
Carbondale	Illinois	37 N	89 W
Champaign	Illinois	40 N	88 W
Chicago	Illinois	41 N	87 W
Decatur	Illinois	39 N	88 W
Joliet	Illinois	41 N	88 W
Peoria	Illinois	40 N	89 W
Quincy	Illinois	39 N	91 W
Rock Island	Illinois	41 N	90 W
Rockford	Illinois	42 N	89 W
Springfield	Illinois	39 N	89 W
Bloomington	Indiana	39 N	86 W
Evansville	Indiana	37 N	87 W
Fort Wayne	Indiana	41 N	85 W
Gary	Indiana	41 N	87 W
Indianapolis	Indiana	39 N	86 W
Marion	Indiana	40 N	85 W
Muncie	Indiana	40 N	85 W
South Bend	Indiana	41 N	86 W
West Lafayette	Indiana	40 N	86 W
Burlington	Iowa	40 N	91 W
Cedar Rapids	Iowa	41 N	91 W
Des Moines	Iowa	41 N	93 W
Dubuque	Iowa	42 N	90 W
Fort Dodge	Iowa	42 N	94 W
Mason City	Iowa	43 N	93 W
Sioux City	Iowa	42 N	96 W
Waterloo	Iowa	42 N	92 W
Dodge City	Kansas	37 N	100 W
Salina	Kansas	38 N	97 W
Topeka	Kansas	39 N	95 W
Wichita	Kansas	37 N	97 W
Ashland	Kentucky	38 N	82 W
Bowling Green	Kentucky	36 N	86 W
Frankfort	Kentucky	38 N	84 W
Hazard	Kentucky	37 N	83 W
Lexington	Kentucky	38 N	84 W
Louisville	Kentucky	38 N	85 W
Middlesboro	Kentucky	36 N	83 W
Owensboro	Kentucky	37 N	87 W
Paducah	Kentucky	37 N	88 W
Alexandria	Louisiana	31 N	92 W
Baton Rouge	Louisiana	30 N	91 W
Monroe	Louisiana	32 N	92 W
New Orleans	Louisiana	29 N	90 W
Shreveport	Louisiana	32 N	93 W
Augusta	Maine	44 N	69 W
Bangor	Maine	44 N	68 W
Portland	Maine	43 N	70 W
Presque Isle	Maine	46 N	68 W
Boston	Massachusetts	42 N	71 W
Lawrence	Massachusetts	42 N	71 W
New Bedford	Massachusetts	41 N	70 W

Pittsfield	Massachusetts	42 N	73 W	Gallup	New Mexico	35 N	108 W
Provincetown	Massachusetts	42 N	70 W	Roswell	New Mexico	33 N	104 W
Springfield	Massachusetts	42 N	72 W	Santa Fe	New Mexico	35 N	105 W
Worcester	Massachusetts	42 N	71 W	Albany	New York	42 N	73 W
Annapolis	Maryland	38 N	76 W	Binghamton	New York	42 N	75 W
Baltimore	Maryland	39 N	76 W	Buffalo	New York	42 N	78 W
Cumberland	Maryland	39 N	78 W	Ithaca	New York	42 N	76 W
Hagerstown	Maryland	39 N	77 W	Massena	New York	44 N	74 W
Salisbury	Maryland	38 N	75 W	New York	New York	40 N	74 W
Ann Arbor	Michigan	42 N	83 W	Olean	New York	42 N	78 W
Boyne City	Michigan	43 N	85 W	Poughkeepsie	New York	41 N	73 W
Detroit	Michigan	42 N	83 W	Rochester	New York	43 N	77 W
Grand Rapids	Michigan	42 N	85 W	Syracuse	New York	43 N	76 W
City	State	Latitude	Longitude	Utica	New York	43 N	75 W
Kalamazoo	Michigan	42 N	85 W	Watertown	New York	43 N	75 W
Lansing	Michigan	42 N	84 W	Asheville	North Carolina	35 N	82 W
Marquette	Michigan	46 N	87 W	Charlotte	North Carolina	35 N	80 W
Pontiac	Michigan	42 N	83 W	Fayetteville	North Carolina	35 N	78 W
Port Huron	Michigan	42 N	82 W	Kitty Hawk	North Carolina	36 N	75 W
Saginaw	Michigan	43 N	83 W	New Bern	North Carolina	35 N	7 W
Traverse City	Michigan	44 N	85 W	City	State	Latitude	Longitude
Bemidji	Minnesota	47 N	94 W	Raleigh	North Carolina	35 N	78 W
Duluth	Minnesota	46 N	92 W	Wilmington	North Carolina	34 N	77 W
International Falls	Minnesota	48 N	93 W	Winston-Salem	North Carolina	36 N	80 W
Rochester	Minnesota	44 N	92 W	Bismarck	North Dakota	46 N	100 W
Saint Cloud	Minnesota	45 N	94 W	Fargo	North Dakota	46 N	96 W
Saint Paul	Minnesota	44 N	93 W	Grand Forks	North Dakota	47 N	97 W
Greenville	Mississippi	33 N	91 W	Minot	North Dakota	48 N	101 W
Jackson	Mississippi	32 N	90 W	Williston	North Dakota	48 N	103 W
Meridian	Mississippi	32 N	88 W	Akron	Ohio	41 N	81 W
Natchez	Mississippi	31 N	91 W	Canton	Ohio	40 N	81 W
Oxford	Mississippi	34 N	89 W	Cincinnati	Ohio	39 N	84 W
Cape Girardeau	Missouri	37 N	89 W	Cleveland	Ohio	41 N	81 W
Columbia	Missouri	38 N	92 W	Columbus	Ohio	39 N	83 W
Jefferson City	Missouri	38 N	92 W	Dayton	Ohio	39 N	84 W
Joplin	Missouri	37 N	94 W	Lima	Ohio	40 N	84 W
Kansas City	Missouri	39 N	94 W	Mansfield	Ohio	40 N	82 W
Poplar Bluff	Missouri	36 N	90 W	Toledo	Ohio	41 N	83 W
Saint Louis	Missouri	38 N	90 W	Youngstown	Ohio	41 N	80 W
Springfield	Missouri	37 N	93 W	Ardmore	Oklahoma	34 N	97 W
Billings	Montana	45 N	108 W	Oklahoma City	Oklahoma	35 N	97 W
Butte	Montana	46 N	112 W	Tulsa	Oklahoma	36 N	95 W
Great Falls	Montana	47 N	111 W	Astoria	Oregon	46 N	123 W
Havre	Montana	48 N	109 W	Baker	Oregon	44 N	117 W
Helena	Montana	46 N	112 W	Coos Bay	Oregon	43 N	124 W
Miles City	Montana	46 N	105 W	Eugene	Oregon	44 N	123 W
Missoula	Montana	46 N	114 W	Klamath Falls	Oregon	42 N	121 W
Lincoln	Nebraska	40 N	96 W	Portland	Oregon	45 N	122 W
North Platte	Nebraska	41 N	100 W	Salem	Oregon	44 N	123 W
Omaha	Nebraska	41 N	96 W	Allentown	Pennsylvania	40 N	75 W
Scottsbluff	Nebraska	41 N	103 W	Erie	Pennsylvania	42 N	89 W
Amsterdam	Netherlands	52 N	4 E	Harrisburg	Pennsylvania	40 N	76 W
Rotterdam	Netherlands	51 N	4 E	Oil City	Pennsylvania	41 N	79 W
Carson City	Nevada	39 N	119 W	Philadelphia	Pennsylvania	39 N	75 W
Elko	Nevada	40 N	115 W	Pittsburgh	Pennsylvania	40 N	80 W
Ely	Nevada	39 N	114 W	Scranton	Pennsylvania	41 N	75 W
Las Vegas	Nevada	36 N	115 W	State College	Pennsylvania	40 N	77 W
Berlin	New Hampshire	44 N	71 W	Williamsport	Pennsylvania	41 N	77 W
Concord	New Hampshire	43 N	71 W	Providence	Rhode Island	41 N	71 W
Manchester	New Hampshire	43 N	71 W	Charleston	South Carolina	32 N	79 W
Atlantic City	New Jersey	39 N	74 W	Columbia	South Carolina	34 N	81 W
Cape May	New Jersey	38 N	74 W	Greenville	South Carolina	34 N	82 W
Long Branch	New Jersey	40 N	74 W	Aberdeen	South Dakota	45 N	98 W
Newton	New Jersey	41 N	74 W	Pierre	South Dakota	44 N	100 W
Trenton	New Jersey	40 N	74 W	Rapid City	South Dakota	44 N	103 W
Albuquerque	New Mexico	35 N	106 W	Sioux Falls	South Dakota	43 N	96 W
Clovis	New Mexico	34 N	103 W	Chattanooga	Tennessee	35 N	85 W

Jackson	Tennessee	35 N	88 W	Tamanrasset	Algeria	22 N	5 E
Knoxville	Tennessee	35 N	83 W	Tindouf	Algeria	27 N	8 W
Memphis	Tennessee	35 N	90 W	Andorra	Andorra	42 N	1 E
Nashville	Tennessee	36 N	86 W	Bahia Blanca	Argentina	38 S	62 W
Oak Ridge	Tennessee	36 N	84 W	Buenos Aires	Argentina	34 S	58 W
Union City	Tennessee	36 N	89 W	Cordoba	Argentina	31 S	64 W
Amarillo	Texas	35 N	101 W	Corrientes	Argentina	27 S	58 W
Austin	Texas	30 N	97 W	Mar del Plata	Argentina	38 S	57 W
Beaumont	Texas	30 N	94 W	Rawson	Argentina	43 S	65 W
Brownsville	Texas	25 N	97 W	Rio Gallegos	Argentina	51 S	69 W
Corpus Christi	Texas	27 N	97 W	Salta	Argentina	24 S	65 W
Dallas	Texas	32 N	96 W	Adelaide	Australia	34 S	138 E
El Paso	Texas	31 N	106 W	Albany	Australia	35 S	117 E
Houston	Texas	29 N	95 W	Alice Springs	Australia	23 S	133 E
Lubbock	Texas	33 N	101 W	Ballarat	Australia	37 S	143 E
San Angelo	Texas	31 N	100 W	Brisbane	Australia	27 S	153 E
San Antonio	Texas	29 N	98 W	Broken Hill	Australia	31 S	141 E
Wichita Falls	Texas	33 N	98 W	Cairns	Australia	16 S	145 E
Cedar City	Utah	37 N	113 W	Canberra	Australia	35 S	149 E
Logan	Utah	41 N	111 W	Cape York	Australia	10 S	142 E
Provo	Utah	40 N	111 W	Carnarvon	Australia	24 S	113 E
Salt Lake City	Utah	40 N	111 W	Darwin	Australia	12 S	130 E
Bennington	Vermont	42 N	73 W	Derby	Australia	17 S	123 E
Burlington	Vermont	44 N	73 W	Eucla	Australia	31 S	128 E
Montpelier	Vermont	44 N	72 W	Geraldton	Australia	28 S	114 E
Rutland	Vermont	43 N	72 W	Hobart	Australia	42 S	147 E
Bluefield	Virginia	37 N	81 W	Kalgoorlie	Australia	30 S	121 E
City	State	Latitude	Longitude	Launceston	Australia	41 S	147 E
Bristol	Virginia	36 N	82 W	Lord Howe Island	Australia	31 S	159 E
Charlottesville	Virginia	38 N	78 W	Melbourne	Australia	37 S	145 E
Chincoteague	Virginia	37 N	75 W	Mount Isa	Australia	20 S	139 E
Danville	Virginia	36 N	79 W	Newcastle Waters	Australia	17 S	133 E
Lynchburg	Virginia	37 N	79 W	Norfolk Island	Australia	29 S	1 E
Norfolk	Virginia	36 N	76 W	City	Country	Latitude	Longitude
Richmond	Virginia	37 N	77 W	Oodnadatta	Australia	27 S	135 E
Roanoke	Virginia	37 N	79 W	Perth	Australia	31 S	115 E
Staunton	Virginia	38 N	79 W	Port Augusta	Australia	32 S	137 E
Winchester	Virginia	39 N	78 W	Port Hedland	Australia	20 S	118 E
Olympia	Washington	47 N	122 W	Rockhampton	Australia	23 S	150 E
Pullman	Washington	46 N	117 W	Sydney	Australia	33 S	151 E
Seattle	Washington	47 N	122 W	Townsville	Australia	19 S	146 E
Spokane	Washington	47 N	117 W	Wiluna	Australia	26 S	120 E
Walla Walla	Washington	46 N	118 W	Yaraka	Australia	24 S	144 E
Yakima	Washington	46 N	120 W	Graz	Austria	47 N	15 E
Charleston	West Virginia	38 N	81 W	Innsbruck	Austria	47 N	11 E
Clarksburg	West Virginia	39 N	80 W	Salzburg	Austria	47 N	13 E
Parkersburg	West Virginia	39 N	81 W	Vienna	Austria	48 N	16 E
Wheeling	West Virginia	40 N	80 W	Freeport	Bahamas	26 N	78 W
Eau Claire	Wisconsin	44 N	91 W	Nassau	Bahamas	25 N	7 W
Green Bay	Wisconsin	44 N	88 W	Antwerp	Belgium	51 N	4 E
La Crosse	Wisconsin	43 N	91 W	Brussels	Belgium	50 N	4 E
Madison	Wisconsin	43 N	89 W	Belmopan	Belize	17 N	88 W
Milwaukee	Wisconsin	43 N	87 W	Hamilton	Bermuda	32 N	64 W
Oshkosh	Wisconsin	44 N	88 W	Thimphu	Bhutan	27 N	89 E
Wausau	Wisconsin	44 N	89 W	La Paz	Bolivia	16 S	68 W
Casper	Wyoming	42 N	106 W	Santa Cruz	Bolivia	17 S	63 W
Cheyenne	Wyoming	41 N	104 W	Sucre	Bolivia	19 S	65 W
Rock Springs	Wyoming	41 N	109 W	Belem	Brazil	1 S	48 W
Sheridan	Wyoming	44 N	106 W	Belo Horizonte	Brazil	19 S	43 W
Tirane	Albania	41 N	19 E	Brasilia	Brazil	15 S	47 W
Calgary	Alberta	51 N	114 W	Cruzeiro do Sul	Brazil	7 S	72 W
Edmonton	Alberta	53 N	113 W	Cuiaba	Brazil	15 S	56 W
Medicine Hat	Alberta	50 N	110 W	Fortaleza	Brazil	3 S	38 W
Algiers	Algeria	36 N	3 E	Manaus	Brazil	3 S	60 W
Annaba	Algeria	36 N	7 E	Porto Alegre	Brazil	30 S	51 W
Bechar	Algeria	31 N	2 W	Porto Velho	Brazil	8 S	63 W
Oran	Algeria	35 N	0 W	Recife	Brazil	8 S	34 W

Rio de Janeiro	Brazil	22 S	43 W	Athens	Greece	37 N	24 E
Salvador	Brazil	12 S	38 W	Iraklion	Greece	35 N	25 E
Santarem	Brazil	2 S	54 W	Kerkira	Greece	39 N	19 E
Sao Paulo	Brazil	23 S	46 W	Rhodes	Greece	36 N	28 E
Teresina	Brazil	5 S	42 W	Thessaloniki	Greece	40 N	22 E
Prince George	British Columbia	53 N	122 W	Godthab	Greenland	64 N	51 W
Prince Rupert	British Columbia	54 N	130 W	Saint George's	Grenada	12 N	61 W
Sydney	British Columbia	46 N	60 W	Basse-Terre	Guadeloupe	16 N	61 W
Vancouver	British Columbia	49 N	123 W	Guatemala City	Guatemala	14 N	90 W
Victoria	British Columbia	48 N	123 W	Conakry	Guinea	9 N	13 W
Yaounde	Cameroon	3 N	11 E	Port-au-Prince	Haiti	18 N	72 W
Largeau	Chad	17 N	19 E	La Ceiba	Honduras	15 N	86 W
Ndjamena	Chad	12 N	13 E	Tegucigalpa	Honduras	14 N	87 W
Barranquilla	Colombia	10 N	74 W	Budapest	Hungary	47 N	19 E
Bogota	Colombia	4 N	74 W	Szeged	Hungary	46 N	20 E
Cali	Colombia	3 N	76 W	Akureyri	Iceland	65 N	18 W
Medellin	Colombia	6 N	75 W	Reykjavik	Iceland	64 N	21 W
Limon	Costa Rica	10 N	83 W	Ahmadabad	India	23 N	72 E
San Jose	Costa Rica	9 N	84 W	Bangalore	India	12 N	77 E
Guantanamo	Cuba	20 N	75 W	Bhopal	India	23 N	77 E
Havana	Cuba	23 N	82 W	Bombay	India	18 N	72 E
Willemstad	Curacao	12 N	68 W	Calcutta	India	22 N	88 E
Nicosia	Cyprus	35 N	33 E	Gangtok	India	27 N	88 E
Brno	Czechoslovakia	49 N	16 E	Hyderabad	India	17 N	78 E
Kosice	Czechoslovakia	48 N	21 E	Kanpur	India	26 N	80 E
Prague	Czechoslovakia	50 N	14 E	Madras	India	13 N	80 E
Santo Domingo	Dominican Republic	18 N	69 W	Nagpur	India	21 N	79 E
Alexandria	Egypt	31 N	29 E	New Delhi	India	28 N	77 E
As Sallum	Egypt	31 N	25 E	Srinagar	India	34 N	74 E
Aswan	Egypt	24 N	32 E	Ambon	Indonesia	3 S	128 E
Cairo	Egypt	30 N	3 E	Banjarmasin	Indonesia	3 S	114 E
Port Said	Egypt	31 N	32 E	Denpasar	Indonesia	8 S	115 E
Suez	Egypt	29 N	32 E	Dili	Indonesia	8 S	125 E
San Salvador	El Salvador	13 N	89 W	Jakarta	Indonesia	6 S	106 E
Helsinki	Finland	60 N	24 E	Manado	Indonesia	1 N	124 E
Kemi	Finland	65 N	24 E	Medan	Indonesia	3 N	98 E
Ajaccio	France	41 N	8 E	Palembang	Indonesia	2 S	104 E
Bordeaux	France	44 N	0 W	Pontianak	Indonesia	0 S	109 E
Brest	France	48 N	4 W	Sorong	Indonesia	0 S	131 E
Calais	France	50 N	1 E	Surabaya	Indonesia	7 S	112 E
City	Country	Latitude	Longitude	Ujungpandang	Indonesia	5 S	119 E
Dijon	France	47 N	5 E	Yogyakarta	Indonesia	7 S	110 E
Le Havre	France	49 N	0 E	Abadan	Iran	30 N	48 E
Limoges	France	45 N	1 E	Esfahan	Iran	32 N	51 E
Lyon	France	45 N	5 E	Mashhad	Iran	36 N	59 E
Marseilles	France	43 N	5 E	Shiraz	Iran	29 N	52 E
Nantes	France	47 N	1 W	Tabriz	Iran	38 N	46 E
Paris	France	48 N	2 E	City	Country	Latitude	Longitude
Strasbourg	France	48 N	7 E	Al Basrah	Iraq	30 N	47 E
Toulouse	France	43 N	1 E	Baghdad	Iraq	33 N	44 E
Cayenne	French Guiana	4 N	52 W	Mosul	Iraq	36 N	43 E
Savannah	Georgia	32 N	81 W	Cork	Ireland	51 N	8 W
Bonn	Germany	50 N	7 E	Dublin	Ireland	53 N	6 W
Braunschweig	Germany	52 N	10 E	Limerick	Ireland	52 N	8 W
Dresden	Germany	51 N	13 E	Elat	Israel	29 N	34 E
Frankfurt am Main	Germany	50 N	8 E	Haifa	Israel	32 N	35 E
Hamburg	Germany	53 N	10 E	Jerusalem	Israel	31 N	35 E
Hannover	Germany	52 N	9 E	Tel Aviv	Israel	32 N	34 E
Leipzig	Germany	51 N	12 E	Bari	Italy	41 N	16 E
Magdeburg	Germany	52 N	11 E	Cagliari	Italy	39 N	9 E
Munich	Germany	48 N	11 E	Florence	Italy	43 N	11 E
Nuremberg	Germany	49 N	11 E	Genoa	Italy	44 N	8 E
Rostock	Germany	54 N	12 E	Messina	Italy	38 N	15 E
Stuttgart	Germany	48 N	9 E	Milan	Italy	45 N	9 E
Weimar	Germany	50 N	11 E	Naples	Italy	40 N	14 E
Berlin	Germany	52 N	13 E	Palermo	Italy	39 N	13 E
Alexandroupolis	Greece	40 N	25 E	Rome	Italy	41 N	12 E

Turin	Italy	45 N	7 E	Invercargill	New Zealand	46 S	168 E
Venice	Italy	45 N	12 E	Milford Sound	New Zealand	44 S	167 E
Kingston	Jamaica	18 N	76 W	Nelson	New Zealand	41 S	173 E
Fukuoka	Japan	33 N	130 E	New Plymouth	New Zealand	39 S	174E
Hakodate	Japan	41 N	140 E	Palmerston North	New Zealand	40 S	175 E
Hiroshima	Japan	34 N	132 E	Wellington	New Zealand	41 S	174 E
Iwo Jima Island	Japan	24 N	141 E	Whangarei	New Zealand	35 S	174 E
Kyoto	Japan	35 N	135 E	Corner Brook	Newfoundland	48 N	57 W
Nagasaki	Japan	32 N	129 E	Fredericton	Newfoundland	45 N	66 W
Nagoya	Japan	35 N	136 E	Gander	Newfoundland	48 N	54 W
Osaka	Japan	34 N	135 E	Saint John's	Newfoundland	47 N	52 W
Sapporo	Japan	43 N	141 E	Pyongyang	North Korea	39 N	125 E
Sendai	Japan	38 N	140 E	Cambridge Bay	NW Territories	69 N	105 W
Tokyo	Japan	35 N	139 E	Coppermine	NW Territories	67 N	115 W
Amman	Jordan	31 N	35 E	Frobisher Bay	NW Territories	63 N	68 W
Mombasa	Kenya	4 S	39 E	Inuvik	NW Territories	68 N	133 W
Nairobi	Kenya	1 S	36 E	Yellowknife	NW Territories	62 N	114 W
Kuwait	Kuwait	29 N	47 E	Bergen	Norway	60 N	5 E
Pakxe	Laos	15 N	105 E	Bodo	Norway	67 N	14 E
Vientiane	Laos	17 N	102 E	Narvik	Norway	68 N	17 E
Riga	Latvia	56 N	24 E	Oslo	Norway	59 N	10 E
Beirut	Lebanon	33 N	35 E	Trondheiin	Norway	63 N	10 E
Tripoli	Lebanon	34 N	35 E	Amherst	Nova Scotia	45 N	64 W
Maseru	Lesotho	29 S	27 E	Halifax	Nova Scotia	44 N	63 W
Monrovia	Liberia	6 N	10 W	Kingston	Nova Scotia	44 N	76 W
Brest	Lithuania	52 N	23 E	New Glasgow	Nova Scotia	45 N	62 W
Vilnius	Lithuania	54 N	25 E	Truro	Nova Scotia	45 N	63 W
Luxembourg	Luxembourg	49 N	6 E	Yarmouth	Nova Scotia	43 N	66 W
Palma	Majorca	39 N	2 E	Fort Severn	Ontario	55 N	87 W
Blantyre	Malawi	15 S	35 E	Kenora	Ontario	49 N	94 W
Lilongwe	Malawi	13 S	33 E	Kitchner	Ontario	43 N	80 W
Kuala Lumpur	Malaysia	3 N	101 E	Moosonee	Ontario	51 N	80 W
Kuching	Malaysia	1 N	110 E	Ottawa	Ontario	45 N	75 W
Pinang	Malaysia	5 N	100 E	Sudbury	Ontario	46 N	81 W
Churchill	Manatoba	58 N	94 W	Thunder Bay	Ontario	48 N	89 W
Norway House	Manatoba	53 N	97 W	Toronto	Ontario	43 N	79 W
Winnipeg	Manitoba	49 N	97 W	Windsor	Ontario	42 N	83 W
Acapulco	Mexico	16 N	99 W	Colon	Panama	9 N	79 W
Cancun	Mexico	21 N	86 W	David	Panama	8 N	82 W
Chihuahua	Mexico	28 N	106 W	Panama	Panama	8 N	79 W
Ciudad Juarez	Mexico	31 N	106 W	Asuncion	Paraguay	25 S	57 W
Durango	Mexico	24 N	104 W	Arequipa	Peru	16 S	71 W
Guadalajara	Mexico	20 N	103 W	Cuzco	Peru	13 S	71 W
Hermosillo	Mexico	29 N	110 W	Iquitos	Peru	3 S	73 W
La Paz	Mexico	24 N	110 W	Lima	Peru	12 S	7 W
Mazatlan	Mexico	23 N	106 W	Trujillo	Peru	8 S	79 W
Merida	Mexico	20 N	89 W	Baguio	Philippines	16 N	120 E
Mexico City	Mexico	19 N	99 W	Cebu	Philippines	10 N	123 E
Monterrey	Mexico	25 N	100 W	Davao	Philippines	7 N	125 E
Tijuana	Mexico	32 N	117 W	Iloilo	Philippines	10 N	122 E
Veracruz	Mexico	19 N	96 W	Manila	Philippines	14 N	121 E
Monte Carlo	Monaco	43 N	7 E	Naga	Philippines	13 N	123 E
Plymouth	Montserrat	16 N	62 W	Subic	Philippines	14 N	120 E
Casablanca	Morocco	33 N	7 W	Zamboanga	Philippines	6 N	122 E
City	Country	Latitude	Longitude	Gdansk	Poland	54 N	18 E
Marrakech	Morocco	31 N	8 W	Krakow	Poland	50 N	19 E
Tangier	Morocco	35 N	5 W	Poznan	Poland	52 N	16 E
Campbellton	New Brunswick	48 N	66 W	Warsaw	Poland	52 N	21 E
Chatham	New Brunswick	47 N	65 W	Lisbon	Portugal	38 N	9 W
Moncton	New Brunswick	46 N	64 W	Porto	Portugal	41 N	8 W
Saint John	New Brunswick	45 N	66 W	Ponce	Puerto Rico	18 N	66 W
Auckland	New Zealand	36 S	174 E	City	Country	Latitude	Longitude
Auckland Islands	New Zealand	50 S	166 E	San Juan	Puerto Rico	18 N	66 W
Christchurch	New Zealand	43 S	172 E	Fort Chimo	Quebec	58 N	68 W
Dunedin	New Zealand	45 S	170 E	Gaspe	Quebec	48 N	64 W
Gisborne	New Zealand	38 S	178 E	Hull	Quebec	45 N	75 W
Hamilton	New Zealand	37 S	175 E	Ivugivik	Quebec	62 N	77 W

Montreal	Quebec	45 N	73 W		Canakkale	Turkey	40 N	26 E
Quebec	Quebec	46 N	71 W		Erzurum	Turkey	39 N	41 E
Rouyn	Quebec	48 N	79 W		Istanbul	Turkey	41 N	28 E
Schefferville	Quebec	54 N	66 W		Izmir	Turkey	38 N	27 E
Prince Albert	Saskatchewan	53 N	105	W	Samsun	Turkey	41 N	36 E
Regina	Saskatchewan	50 N	104	W	Charlotte Amalie	Virgin Islands	18 N	64 W
Saskatoon	Saskatchewan	52 N	106	W	Christiansted	Virgin Islands	17 N	64 W
Uranium City	Saskatchewan	59 N	108	W	Midway Islands	USA	28 N	177 W
Dhahran	Saudi Arabia	26 N	5	E	Aberdeen	United Kingdom	57 N	2 W
Mecca	Saudi Arabia	21 N	39	E	Belfast	United Kingdom	54 N	5 W
Medina	Saudi Arabia	24 N	39	E	Birmingham	United Kingdom	52 N	1 W
Riyadh	Saudi Arabia	24 N	46	E	Cardiff	United Kingdom	51 N	3 W
Bloemfontein	South Africa	29 S	26	E	Edinburgh	United Kingdom	55 N	3 W
Cape Town	South Africa	33 S	18	E	Glasgow	United Kingdom	55 N	4 W
Durban	South Africa	29 S	31	E	Inverness	United Kingdom	57 N	4 W
Johannesburg	South Africa	26 S	28	E	Lerwick	United Kingdom	60 N	1 W
Port Elizabeth	South Africa	33 S	25	E	Liverpool	United Kingdom	53 N	3 W
Pretoria	South Africa	25 S	28	E	London	United Kingdom	51 N	0 W
Pusan	South Korea	35 N	129	E	Londonderry	United Kingdom	55 N	7 W
Seoul	South Korea	37 N	127	E	Plymouth	United Kingdom	50 N	4 W
Barcelona	Spain	41 N	2	E	Portsmouth	United Kingdom	50 N	1 W
Bilbao	Spain	43 N	2	W	York	United Kingdom	53 N	1 W
Granada	Spain	37 N	3	W	City	Country	Latitude	Longitude
La Coruna	Spain	43 N	8	W	Montevideo	Uruguay	34 S	56 W
Madrid	Spain	40 N	3	W	Caracas	Venezuela	10 N	66 W
Seville	Spain	37 N	5	W	Ciudad Bolivia	Venezuela	8 N	70 W
Valencia	Spain	39 N	0	W	Maracaibo	Venezuela	10 N	71 W
Zaragoza	Spain	41 N	0	W	Dawson	Yukon Territory	64 N	139 W
Colombo	Sri Lanka	6 N	79	E	Dawson Creek	Yukon Territory	55 N	120 W
Jaffna	Sri Lanka	9 N	80	E	Old Crow	Yukon Territory	67 N	139 W
Goteborg	Sweden	57 N	11	E	Watson Lake	Yukon Territory	60 N	128 W
Kiruna	Sweden	67 N	20	E	Whitehorse	Yukon Territory	60 N	135 W
Stockholm	Sweden	59 N	18	E				
Sundsvall	Sweden	62 N	17	E				
Bern	Switzerland	46 N	7	E				
Geneva	Switzerland	46 N	6	E				
Zurich	Switzerland	47 N	8	E				
Al Qamishli	Syria	37 N	41	E				
Allepo	Syria	36 N	37	E				
Damascus	Syria	33 N	36	E				
Kaohsiung	Taiwan	22 N	120	E				
Taipei	Taiwan	25 N	121	E				
Bangkok	Thailand	13 N	100	E				
Chiang Mai	Thailand	18 N	98	E				
Adana	Turkey	37 N	35	E				
Ankara	Turkey	39 N	32	E				

Appendix B - What is X10?

The X10 POWERHOUSE System is a line of home automation products designed to control lights and appliances using existing electrical wiring as a communications medium. X10 is the “De Facto” standard for Power Line Carrier (PLC) transmission. The code format was first introduced in 1978 and is compatible with many manufacture’s versions of PLC devices.

X10 Addresses

All X10 receiver modules have two code dials: a house (letter) code dial and a unit (number) code dial. There are 16 house codes, ranging from the letters A to P. There are also 16 unit codes, ranging from 1 to 16. That means there are 256 possible combinations of module addresses.

X10 Theory

X10 is based on a technique known as carrier current communication. High frequency bursts are sent out over the power line that is received by the receiver modules. The high frequency bursts, or bits, are sent to coincide with the zero crossing of the AC power line. The receiver modules know to start listening to the AC line for a bit sequence when it detects a zero crossing. The format used by X10 is an 11-bit sequence consisting of a start code, a house code, and either a function code or a module number. The first 2 bits represent a Start Code, the next four represent the HouseCode, and the last five represent the KeyCode, either a NumberCode (1 through 16) or a Function Code (ON, OFF, All Lights On, etc.). This complete block, (StartCode, HouseCode, KeyCode) is always transmitted at least twice.

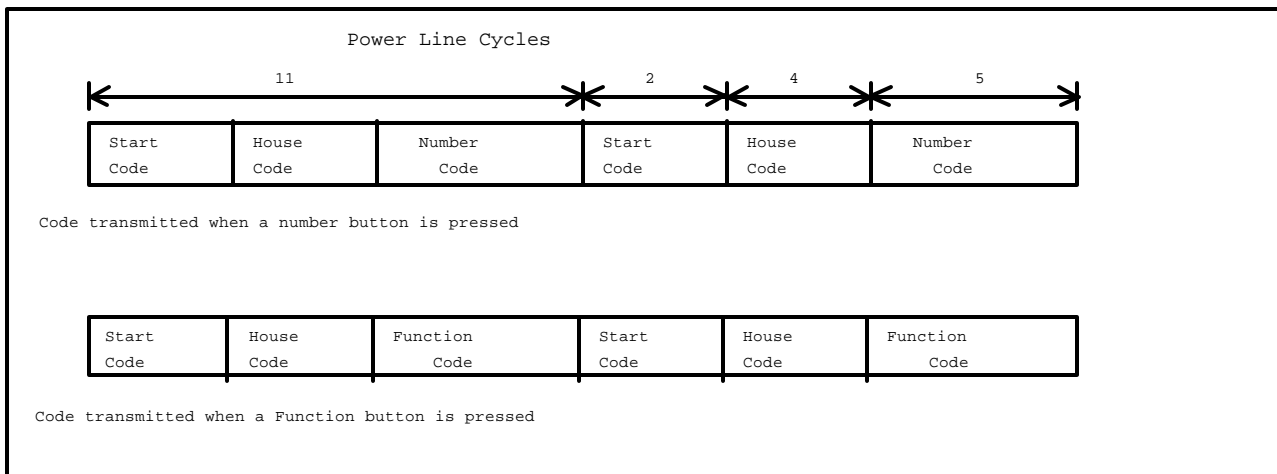

To understand why an X10 transmission can only contain either a module number or a function code, you need to understand how a manual X10 system works. Use the MegaController to see what is being sent when a button is pressed from a manual control console. You will see that when a number button is pressed, it sends the HouseCode-NumberCode to select the module. When a function button is pressed, it sends the HouseCode-FunctionCode to control the selected module.

DIM/BRIGHT Limitations

The Power Line Interface module can receive Dim and Bright codes, but the output will represent the first Dim or Bright code received, followed by every third code received, i.e., the output from the Power Line Interface will not be a continuous stream of Dim or Bright codes as transmitted.

What this means: The controller keeps track of Dim/Bright levels for any of the 256 X10 devices. Since it cannot reliably receive Dim/Bright codes sent by another X10 controller, any Dim or Bright code received will be ignored. This means that as long as you use the controller to dim or brighten a light, it will know exactly what level of brightness the light is at. But if you dim or brighten a light using another controller, those commands will be ignored and not update the Dim/Bright level for the light.

The Bottom Line - If you use the controller to control dim/bright levels, dimming or brightening using another X10 controller or at the switch itself, will cause it to get out of sync with what the real level is.

Appendix C - Examples

The following examples are from actual Schedules.

Example C1. Toggle lights ON and OFF for 10 minutes after the security system is tripped.

```
EVENT: Start Timer
If
  /* L1 is connected to alarm output */
  (XSEQ: L-1 L-ON ) Received within 3 seconds
Then
  (T:Alarm Timer) LOAD with 0:10:00
  (XCMD:A-7 A-ON)
End
```

```
EVENT: Toggle Security Lights
If
  (X:A-7) is ON
  and (T:Alarm Timer) is Running
Then
  (XCMD:A-7 A-OFF)
Else
  (XCMD:A-7 A-ON)
End
```

Note: During the time the lights are toggling ON and OFF, the X10 network may become saturated by the repeated ON/OFF commands and the controller may not see other X10 transmissions! It may be necessary to put a delay statement in the THEN section to allow time for other X10 transmissions.

Example C2. Using the modem to call a Pager number.

```
EVENT: Call Pager Number
If
  (XSEQ: P-1 P-ON P-1 P-ON) Received within 6 seconds
Then
  /* Call Bob's pager, display 1234 */
  ASCII-Out: 'ATDT555-1212,,,,1234'
End
```

Note: This example assumes a modem connection as shown in the Modem Section of the manual.

Example C3. If/And/Or.

```
EVENT AND/OR Sample Event
If
  (X:Make Coffee C 1) is ON
-AND-
  Time = 6:00 AM .MTWTF.
  or Time = 10:00 AM S.....S
Then
  (X: Coffee Maker C 2) ON
  (X: Make Coffee C 1) Idle
  Delay 01:00:00
  (X: Coffee Maker C 2) OFF
End
```

In this example, Otto defines a 'Make Coffee' switch as X10 address C1. He turns this switch ON at night only if he puts coffee and water in the coffee machine. If this switch is ON -AND-, it's 6 AM weekdays OR 10 AM weekends, then turn on the coffee maker, set the 'Make Coffee' switch to Idle, then turn off the coffee maker after 1 hour.

Example C4. Setup a smart answer Modem.

```

EVENT: Smart Answer Modem Pickup
If
  ASCII-In:'RING'
  /* Have Modem pickup if 2 rings, */
  /* followed by no rings for 20 sec, */
  /* and 1 ring between 20 and 60 sec */
  /* Set remote modem to answer on 0 rings */
Then
  (V:RingCount) INCREMENT
  -If
  | (V:RingCount) is Equal to 1
  /Then
  | (T:RingMin) LOAD with 0:00:10
  -End
  -If
  | (V:RingCount) is Equal to 2
/Then
  | -If
  | | (T:RingMin) is Running
  | | /* 2nd ring within 10 seconds? */
  | /Then
  | | /* Load the min and max times for */
  | | /* the 3rd ring to fall between */
  | | (T:RingMin) LOAD with 0:00:20
  | | (T:RingMax) LOAD with 0:00:59
  | /Else
  | | /* Nope, rang after 10 seconds */
  | | (V:RingCount) CLEAR
  | -End
  -End
  -If
  | (V:RingCount) is Equal to 3
/Then
  | -If
  | | (T:RingMin) is Stopped
  | | and (T:RingMax) is Running
  | | /* 3rd ring between min and max? */
  | /Then
  | | (V:RingCount) CLEAR
  | | ASCII-Out:'ATA'
  | /Else
  | | (V:RingCount) CLEAR
  | -End
  -End
  -If
  | (V:RingCount) is Greater than 3
  | /* If RingCount goes over 3, clear */
  /Then
  | (V:RingCount) CLEAR
  -End
End

EVENT: Clear RingCount if maxtimeout
If
  (T:RingMax) is Expiring
  /* If no 3rd ring before max time */
  /* times out, clear RingCount */
Then
  (V:RingCount) CLEAR
End

```

If you use a modem with the controller and have to share a line with an answering machine, the normal answering mode will not work. If you set the answering machine to answer on fewer number of rings than the controller, you'll never connect. The same goes for the opposite, if the controller answers on fewer rings than your answering machine, you'll never record any calls.

Example 3 shows how one can tell the modem to pick up the line after a certain pattern of rings and pauses, thus bypassing an answering machine. This example assumes the answering machine will pick up on the 4th ring.

If 2 rings are detected within 10 seconds, followed by a 20 second period with no rings, the controller will instruct the modem to pickup if 1 more ring occurs before the maximum timeout.